

ATTENTION

RAM AIR RIDE SYSTEM WARNING

Due to the complexity of the Ram's factory air ride system, we highly recommend using only an experienced suspension specialist for installation. BDS is not liable for any costs associated with problems resulting from improper installation of this system.

All pressurized air suspension components contain high pressure air (up to 220 psi). Extreme caution must be used during the installation of this system to prevent component damage or personal injury.

Failure to disable the air suspension system prior to installation can result in excessive leakage from the system and damage to the air compressor assembly.

Failure to prevent and check for leaks or restrictions in the air line connections can result in damage to the air system compressor, and set error codes, and lock the ASCM. Only the RAM dealership has the ability to access and reset the ASCM. The recharging of the system may also be required as well as in depth diagnostics and recalibration of the system to restore proper function.

BDS lists an estimated installation time of 10 hours for the basic installation of this system. This doesn't include time for diagnostics and repair that could result from a leaking fitting or other problem associated with the installation. BDS will not cover any costs associated the labor required to correct the system.

REAR AIR BAG INSTALLATION WARNING

Extreme care must be taken to follow the steps of these instructions to prevent damage to the rear air bags during the installation and filling process. Costly replacement air bags and a trip to a RAM dealer for diagnostics and system fill may be required if leaks are present or the air bags are not installed according to these instructions.

BDS is not liable for damaged air bags or personal injury as a result of improper installation.

INSTALLATION GUIDE



Part#: 022403



HARDCORE LIMITED LIFETIME WARRANTY

4" High Clearance Suspension System

Dodge Ram 1500 Air Ride 4WD | 2013-2015

Rev. 081717

491 W. Garfield Ave., Coldwater, MI 49036 • Phone: 517-279-2135

E-mail: tech-bds@sporttruckusainc.com

Read And Understand All Instructions And Warnings Prior To Installation Of System And Operation Of Vehicle.

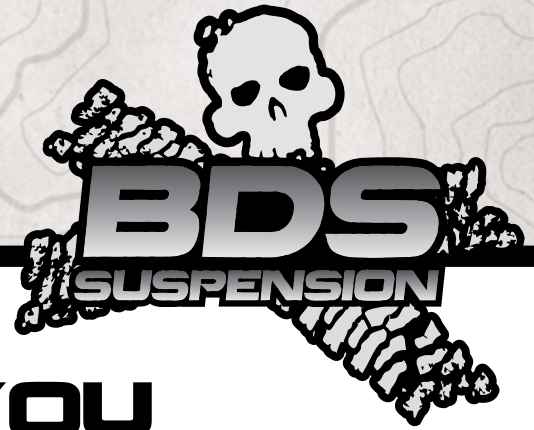

THANK YOU

Your truck is about to be fitted with the best suspension system on the market today. That means you will be driving the baddest looking truck in the neighborhood, and you'll have the warranty to ensure that it stays that way for years to come. Thank you for choosing BDS Suspension!

BEFORE YOU START

BDS Suspension Co. recommends this system be installed by a professional technician. In addition to these instructions, professional knowledge of disassembly/ reassembly procedures and post installation checks must be known.

FOR YOUR SAFETY

Certain BDS Suspension products are intended to improve off-road performance. Modifying your vehicle for off-road use may result in the vehicle handling differently than a factory equipped vehicle. Extreme care must be used to prevent loss of control or vehicle rollover. Failure to drive your modified vehicle safely may result in serious injury or death. BDS Suspension Co. does not recommend the combined use of suspension lifts, body lifts, or other lifting devices. You should never operate your modified vehicle under the influence of alcohol or drugs. Always drive your modified vehicle at reduced speeds to ensure your ability to control your vehicle under all driving conditions. Always wear your seat belt.

BEFORE INSTALLATION

- Special literature required: OE Service Manual for model/year of vehicle. Refer to manual for proper disassembly/reassembly procedures of OE and related components.
- Adhere to recommendations when replacement fasteners, retainers and keepers are called out in the OE manual.
- Larger rim and tire combinations may increase leverage on suspension, steering, and related components. When selecting combinations larger than OE, consider the additional stress you could be inducing on the OE and related components.
- Post suspension system vehicles may experience drive line vibrations. Angles may require tuning, slider on shaft may require replacement, shafts may need to be lengthened or trued, and U-joints may need to be replaced.
- Secure and properly block vehicle prior to installation of BDS Suspension components. Always wear safety glasses when using power tools.
- If installation is to be performed without a hoist, BDS Suspension Co. recommends rear alterations first.
- Due to payload options and initial ride height variances, the amount of lift is a base figure. Final ride height dimensions may vary in accordance to original vehicle attitude. Always measure the attitude prior to beginning installation.



Visit 560plus.com for more information.

TIRES AND WHEELS

4" Lift

- 35x12.50 on 17x9 with 4-1/2" backspacing
- 35x12.50 on 18 or 20x9 with 5" backspacing

Stock 17" and 18" wheels cannot be re-installed.
Stock 20" can only be re-installed with the factory tire.

BEFORE YOU DRIVE

Check all fasteners for proper torque. Check to ensure for adequate clearance between all rotating, mobile, fixed, and heated members. Verify clearance between exhaust and brake lines, fuel lines, fuel tank, floor boards and wiring harness. Check steering gear for clearance. Test and inspect brake system.

Perform steering sweep to ensure front brake hoses have adequate slack and do not contact any rotating, mobile or heated members. Inspect rear brake hoses at full extension for adequate slack. Failure to perform hose check/ replacement may result in component failure. Longer replacement hoses, if needed can be purchased from a local parts supplier.

Perform head light check and adjustment.

Re-torque all fasteners after 500 miles. Always inspect fasteners and components during routine servicing.

CONTENTS OF YOUR KIT

022630 & 022631 Box Kit

Part #	Qty	Description
02230	1	Steering Knuckle - DS
02231	1	Steering Knuckle - PS
20277	2	Tie Rod End
N16FJ	2	Tie Rod End Jam Nut

022625 Box Kit

Part #	Qty	Description
01295B	1	HC Front Crossmember
02389B	1	Diff.Drop Bracket - PS
02278B	1	Diff. Drop Bracket - DS Front
02277B	1	Diff. Drop Bracket - DS Rear
01236B	1	Diff. Drop Bracket - DS Outer Front
6865833	1	CV Boot Clamp

022403 Box Kit

Part #	Qty	Description
02242	1	Front Drive Shaft Spacer
01298B	1	Differential Skid Plate
02002ZP	4	M18-2.5 x 150 Class 10.9 Bolt
N18MPT	4	M18 x 2.5 Prevailing Torque Nut
01264	8	Square Washer
01296B	1	HC Rear Crossmember
099000	4	11.5in Nylon Cable Tie
02776	2	Front Strut Spacer
911114	2	Sway Bar Link Extension
117300006	4	Large Stem Washer
01499	2	1/4in Spacer
342701	1	Loctite - 1ml
22531	2	Front Brake Line
5188	2	Snap In Brake Line Clip
CCW-03-050	4	Crush Washer
01274	2	Brake Line Bracket
01267B	2	Strut Spacer

022403 Box Kit (Cont.)

Part #	Qty	Description
660	1	Bolt Pack - Differential Hardware
	3	12mm-1.75 x 30mm bolt
	2	12mm-1.75 x 40mm bolt
	4	12mm-1.75 x 55mm bolt
	2	12mm-1.75 x 60mm bolt
	13	12mm flat washer
	4	12mm-1.75 prevailing torque nut
	3	1/2"-13 x 1-1/2" bolt
	4	1/2"-13 X 1-1/4" bolt
	3	1/2"-13 prevailing torque nut
	10	1/2" SAE thru-hardened washer
662	1	Bolt Pack- Main Hardware
	2	1/4"-20 x 1/2" bolt
	2	1/4"-20 prevailing torque nut
	4	1/4" SAE washer
	2	Wire Clip
	6	10mm-1.50 Prevailing torque nut
	6	10mm flat washer
	2	1/2"-13 x 1-1/4" bolt
	2	1/2"-13 prevailing torque nut
	4	1/2" SAE flat washer
	2	7/16"-14 Nylock nut
663	1	Bolt Pack - Driveshaft Spacer
	2	12mm-1.75mm x 45mm bolt
	2	12mm flat washer

022259 Box Kit		
Part #	Qty	Description
02280B	1	Rear Track Bar Bracket
109	1	1 x 1/8" x 1.36" Sleeve
01292B	1	Control Arm Relocation - Drv
01293B	1	Control Arm Relocation - Pass
110	2	1" x 1/8" x 2-3/8" Sleeve
SBLA	2	Brakeline Relocation Brackets
911103	2	Sway Bar Links
SB58BK	4	Sway Bar Link Bushings
62147	4	5/8" x 12mm ID x 1-3/8" Sleeve
02774	2	Rear Air Bag Spacer
01290	2	Shock Nut Tab
01928B	2	Bump Stop Extension
01294	2	Bump Stop Nut Plate

022259 Box Kit (Cont.)		
Part #	Qty	Description
SV203	4	Air Line Fitting
02777	1	Ram Rebel Air Sensor Bracket - Drv
02778	1	Ram Rebel Air Sensor Bracket - Pass
457	1	Bolt Pack - Air Fittings / Rear Air Bag Spacer
	6	5/16"-18 nylock nut
	6	1/4" USS washer
	2	90° push to connect air fitting
	2	Straight push to connect air fitting
	4	3.5" Long Air Line
807	1	Bolt Pack - Rear Sway Bar Links
	4	12mm x 60mm bolt
	8	7/16" USS washer
	4	12mm Prevailing torque nut
808	1	Bolt Pack - Rear Bump Stops
	4	3/8"-16 x 7/8" bolt
	4	3/8" SAE washer
813	1	Bolt Pack - Rear
	3	9/16" x 3" bolt
	1	9/16" Prevailing torque nut
	4	9/16" SAE washer
	2	5/8" x 4-1/2" bolt
	2	5/8" Prevailing torque nut
	4	5/8" SAE washer
	9	3/8" x 1-1/4" Bolt
	9	3/8" Prevailing torque nut
	18	3/8" SAET washer
	1	8mm x 30mm bolt
	1	5/16" USS washer
	2	1/4" x 3/4" bolt
	2	1/4" nylock nut
	4	1/4" SAE washer

TECH TIPS

TROUBLESHOOTING INFORMATION FOR YOUR VEHICLE

1. Fits factory air ride equipped trucks only. This system has not been tested on the Ram Rebel models.
2. The factory air ride is a closed loop system. Opening the system more times than recommended in the lift instructions will require the system to be recharged. This can be done at any Ram dealer service department. A scan tool is needed to access the air control module to perform the service.
3. Due to the complexity of your Ram's factory air ride system, we highly recommend using an experienced suspension specialist for installation.

INSTALLATION INSTRUCTIONS

PRE-INSTALLATION MEASUREMENTS

Measure from the center of the wheel up to the bottom edge of the wheel opening

LF _____ RF _____ LR _____ RR _____

SPECIAL TOOLS

36mm Socket (Hub nut)

PRE-INSTALLATION NOTE

1. Extreme care must be taken to follow the steps of these instructions to prevent any leaks or damage to the air bags during the installation process. Costly replacement air bags or a trip to a Ram dealer for diagnostics may be required if leaks are present or the air bags are not installed according to these instructions.

FRONT INSTALLATION

1. Park the vehicle on a clean, flat surface and block the rear wheels for safety.
2. Turn off the air ride using through the vehicles control panel: Uconnect>settings>suspension>tire jack mode.
3. Disconnect the battery.
4. Raise the front of the vehicle and support with jack stands under the frame rails.
5. Remove the wheels.
6. Disconnect the sway bar links from the sway bar. Leave them attached to the lower control arm (Fig 1).

FIGURE 1

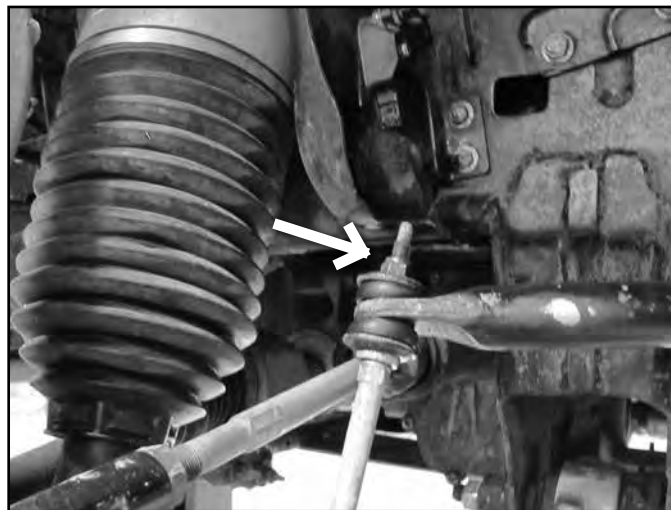

7. Remove and discard the OE front skid plate, if equipped (Fig 2).

FIGURE 2



8. Disconnect the tie rod ends from the steering knuckles. Remove the jam nuts. Use the appropriate puller to separate the tie rod end from the steering knuckle. (Fig 3)

FIGURE 3



9. Disconnect the ABS brake line at the frame. Remove it from the retaining clips. (Fig 4)

FIGURE 4

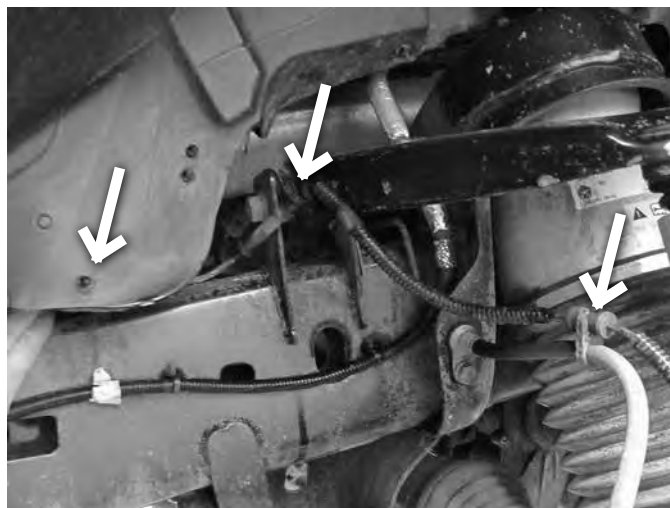

10. Disconnect the driver's side front brake hose from the caliper. Retain the banjo bolt and discard the crush washers.
11. Disconnect the hard line from the brake hose fitting at the frame. Remove the hose fitting retaining bolt and remove the hose from the vehicle. Retain the hose fitting mounting bolt.

- Attach the provided brake line relocation bracket (01274) to the frame where the original line mounted. Fasten the bracket with the OE fitting bolt through the original threaded hole and the corresponding small hole in the new bracket. Align the other mounting hole in the bracket with the brake line hole in the frame and fasten with a 1/2" x 1-1/4" bolt, nut and 1/2" SAE washers (BP 662). Torque the OE bolt to 10 ft-lbs and the 1/2" bolt to 50 ft-lbs. (Fig 5)

FIGURE 5



- Route the new stainless steel brake line through the relocation bracket and attach it to the hard line. Tighten the fitting securely. Fasten the line to the bracket with the provided retaining clip.
- Attach the opposite end of the new brake line to the caliper with the OE banjo bolt and one new crush washer on each side of the fitting. Torque the banjo bolt to 18 ft-lbs.
- Repeat brake line installation on the passenger's side of the vehicle.
- Remove the brake caliper anchor bracket bolts and pull the caliper free from the steering knuckle and rotor. Hang the caliper securely out of the way. Retain caliper mounting hardware. Remove the brake rotor from the hub.



Tip Do not allow the brake caliper to hang from the brake hose.

- Remove the hub axle nut using a 36mm socket. Retain nut.
- Loosen but do not remove the lower control arm bolts.
- Disconnect the CV axles from the differential by carefully prying or tapping on the CV at the differential to disengage the internal retaining clip. Pry the shaft out just enough to release the clip and leave the axle on the differential at this time (Fig 6).

FIGURE 6



20. Support the lower control arm with a hydraulic jack. First remove the air line from the fitting followed by the three air spring to frame mounting nuts (Fig 7).
21. Loosen the air spring to lower control arm hardware (Fig 8). Remove the nut from the bolt and leave the bolt in place to temporarily retain the air spring to the lower control arm. Retain the nut.

FIGURE 7



FIGURE 8



22. Remove the upper and lower ball joint nuts. Reinstall the nuts a few turns by hand. Separate the upper and lower ball joints from the steering knuckle using the appropriate puller. Take care not to damage the ball joint.
23. Remove the upper ball joint nut. Lower the jack enough to allow removal of the air spring and shock assembly. Remove the lower mounting bolt and remove the air spring from the vehicle. Mark the air bag from the appropriate side (driver's or passenger's). Retain mounting bolt and upper ball joint nut.
24. Continue to lower the jack allowing the knuckle, CV axle and lower control arm to swing down. Slide the CV axle off of the differential. Remove the CV axle from hub.

FIGURE 9



25. Remove the lower ball joint nut and remove the knuckle from the lower control arm. Retain the lower ball joint nut. (Fig 9)
26. Repeat the knuckle removal process on the other side.
27. Remove the three bolts mounting the hub bearing assembly to the OE steering knuckles. Retain the mounting bolts. Remove the hub assembly and dust shield from the knuckle.
28. Install the hubs in the corresponding new knuckles (02230, 02231) and fasten with the stock mounting bolts. Index the hub so that the ABS line runs out the front side of the knuckle toward the steering arm. Use Loctite on the bolt threads and torque to 125 ft-lbs. (Fig 10)

FIGURE 10



29. Remove the lower control arms from the frame. Retain hardware (Fig 11).

FIGURE 11

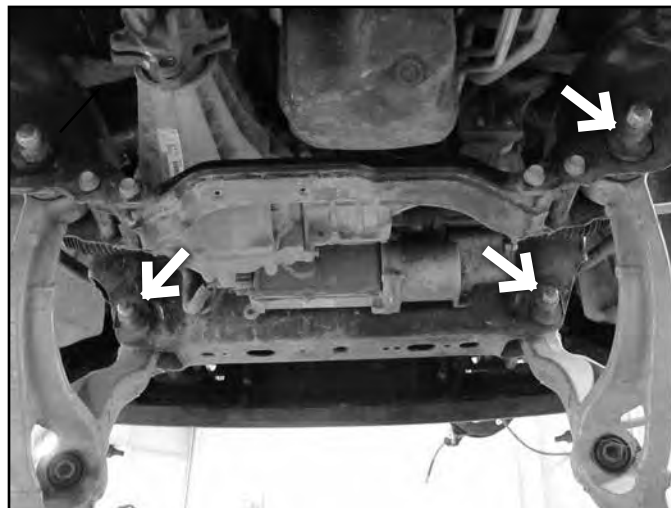

30. Make indexing marks on the front drive shaft and differential input flange for realignment later. Remove the four bolts and disconnect the drive shaft from the differential. Support the driveshaft to keep the CV boot from binding. Discard mounting bolts. (Fig 12).



Tip *Failure to support the driveshaft can lead to pinching the rubber boot at the CV joint which can damage the seal causing a leak and premature wear on the joint.*

FIGURE 12

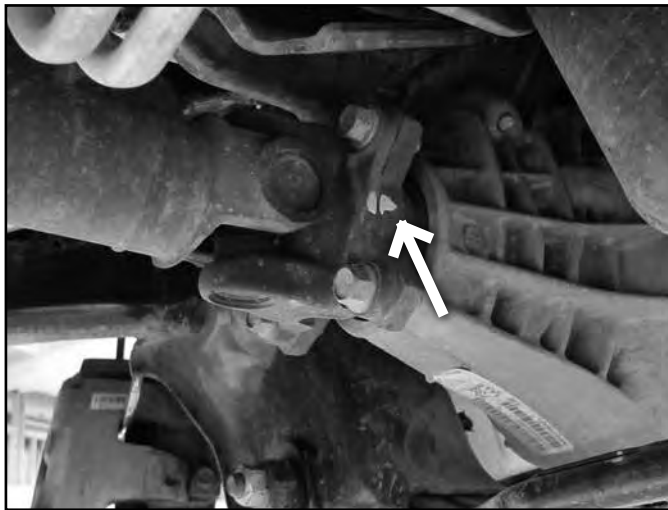

31. Remove the four bolts mounting the OE rear crossmember to the frame rails and remove the crossmember from the vehicle. Discard the crossmember and the hardware.

FRONT DIFFERENTIAL DISASSEMBLY

32. Using a jack, support the differential. Remove the wiring harness from the differential.
33. Loosen and remove the two forward-most differential mounting bolts on the driver's side (Fig 13A). Loosen but do not remove the three rear driver's side bolts (Fig 14) and the two passenger's side bolts (Fig 15A). On the passenger's side, if equipped, remove the differential actuator cable bracket. It will not be reused. DIESEL MODELS - DRV Side: Diesel model vehicles have tighter clearance between the motor and front driver's side differential mount. It may be easier to remove the entire mount with the differential. If so, support the motor and remove the 2 motor mount bracket to differential bracket bolts as well as the main motor mount bolt (Fig 13B). Once the differential is removed, remove the bracket from the differential (Fig 13C) and reinstall in the vehicle and tighten hardware. DIESEL MODELS - PASS Side: There is a harmonic dampener attached to the passenger's side differential mount. Remove with the differential and save (Fig 15B).

FIGURE 13A

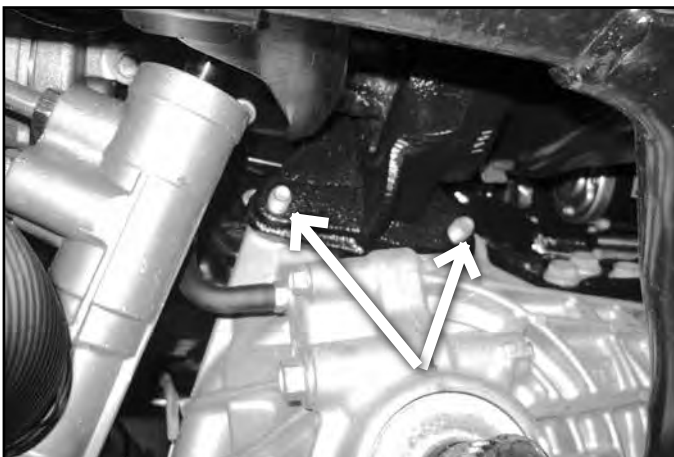

FIGURE 13B



FIGURE 13C

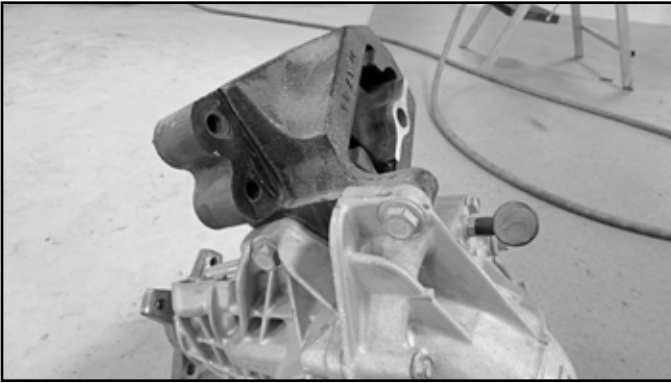

FIGURE 14

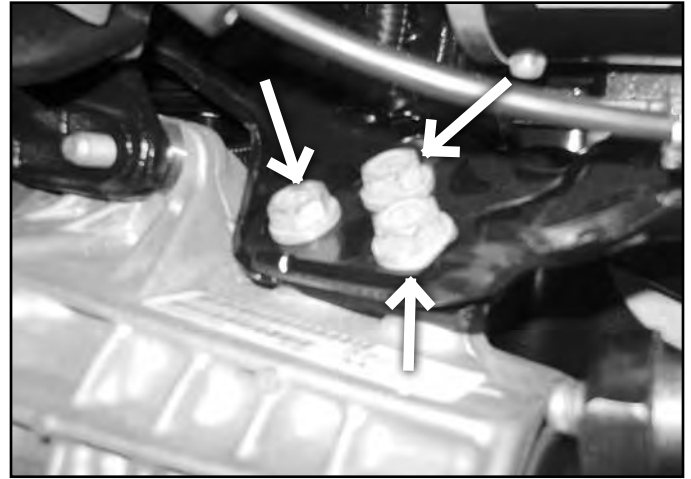

FIGURE 15A

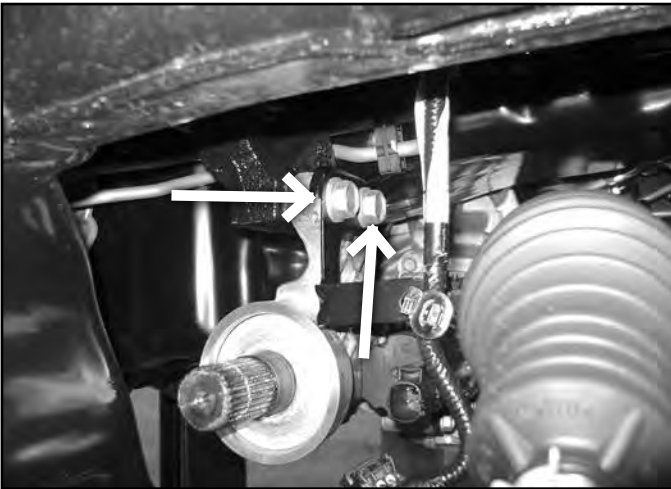
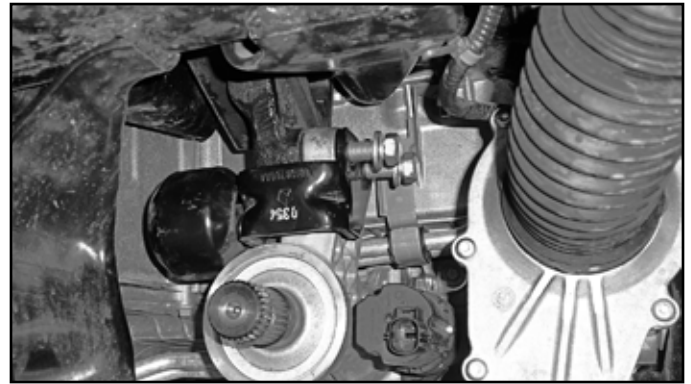
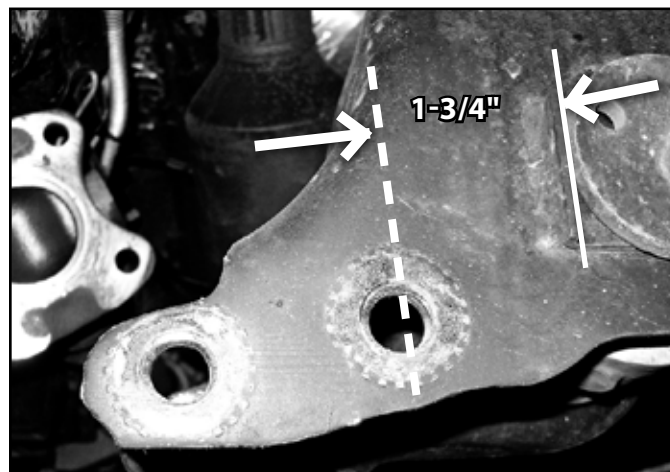

FIGURE 15B



34. With the differential securely supported, remove the remaining bolts and lower the differential from the vehicle.
35. The driver's side rear lower control arm pocket must be trimmed to provide clearance for the differential in its lowered position. Measure inward from the inside edge of the alignment cam slot 1-3/4" and mark. Repeat on the opposite side of the pocket. Make a continuous line connecting the two marks over the top edge of the pocket. Trim the pocket on the line with a sawzall or cut off wheel. Paint any exposed metal to prevent corrosion (Fig 16).

FIGURE 16



DIFFERENTIAL INSTALLATION

36. Install the provided passenger's side differential drop bracket (02389) to the original frame mount with OE hardware. The bracket installs with the offset forward as shown (Fig 17). Leave hardware loose.

FIGURE 17



37. Install the two front driver's side differential drop brackets so that the bracket with the small offset (01236) is toward the outside of the vehicle (offsetting out) and the one with the bigger offset (02278) is on the inside (offsetting in). The brackets should taper down in height as they go toward the rear of the vehicle (for correction of the pinion angle). Fasten the brackets to the frame with two 12mm x 40mm bolts and washers into the factory threaded holes (BP 660). Leave hardware loose. (Fig. 18)
38. Install the driver's side rear differential drop bracket (01238) to the frame with three 1/2" x 1-1/2" bolts and 1/2" SAE washers (BP 660). The bracket will have the gusset plate towards the front of the vehicle. Leave hardware loose (Fig. 19).

FIGURE 18



FIGURE 19



39. Using a jack (and an assistant to aid in balancing) raise the differential up to the new brackets.
40. Attach the differential to the driver's side front bracket and passenger's side bracket (Fig 20) with 12mm x 55mm bolts, nuts and washers (BP 660), the drivers side brackets shown will require 1/4" spacers located in the 022403 bag kit. (Fig 21) Attach the drivers side rear bracket to the differential (Fig 22a, b) with 12mm x 30mm bolts and washers (BP 660). Leave all differential hardware loose. DIESEL MODELS: When attaching the differential to the passenger's side drop bracket, reinstall the harmonic dampener and use the (2) 12mm x 60mm bolts provided (BP 660) in place of the 12mm x 55mm bolts (Fig 23).

FIGURE 20 - PASSENGER SIDE



FIGURE 21 - DRIVER SIDE

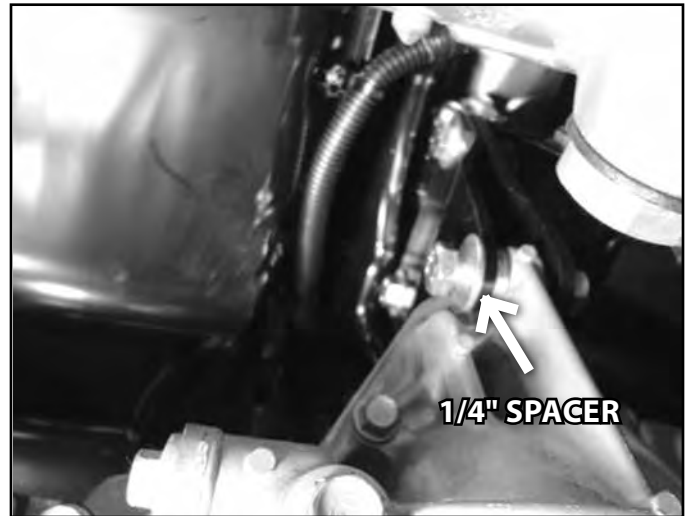

FIGURE 22A - DRIVER SIDE



FIGURE 22B - DRIVER SIDE



FIGURE 23



41. Torque all 14 differential mounting bolts. Torque the 1/2" hardware to 65 ft-lbs and the 12mm hardware to 50 ft-lbs.
42. Remove the front differential wiring harness from factory clips to give enough slack to reach the differential. Reattach to the differential and tie up extra slack with provided zip ties.
43. Install the new front crossmember (01295) in the OE front lower control arm pockets (Fig 24) and loosely fasten with the provided 18mm x 150mm bolts, nuts in conjunction with the provided rectangle cam slot washers (01264).

Note: The offset in the crossmember goes to the front, bolts run from front to rear.

FIGURE 24



44. Install the new rear crossmember (01296) in the OE rear lower control arm pockets and loosely fasten with the provided 18mm x 150mm bolts, nuts in conjunction with the provided rectangle cam slot washers (01264). Run the bolts from front to rear and leave loose at this time. (Fig. 25)

FIGURE 25



45. Install the new differential skid plate to the front crossmember with $\frac{1}{2}$ " x 1-1/4" bolts and $\frac{1}{2}$ " SAE washers (BP #660) into the welded nuts in the crossmember. Install the back of the skid plate to the rear crossmember with $\frac{1}{2}$ " x 1-1/4" bolts and $\frac{1}{2}$ " SAE washers (BP #660) into the welded nuts in the crossmember. Leave hardware loose.
46. Install the lower control arms in the front and rear crossmembers. Attach the control arms to the crossmembers with the OE cam bolts, washers and nuts running from front to rear. Leave hardware loose. (Fig 26)

FIGURE 26



47. With the lower control arms installed, torque the 18mm crossmember mounting bolts to 220 ft-lbs. Torque the 1/2" differential skid plate hardware to 65 ft-lbs.
48. Install the provided drive shaft spacer (02242) on the differential input flange. Attach the front driveshaft to the differential by aligning the marks made earlier. Fasten the driveshaft and spacer to the differential flange with 12mm x 45mm bolts and 12mm washers (BP #663). Use loctite on the bolt threads and torque to 55 ft-lbs. (Fig 27)

FIGURE 27



FRONT AIR LINE & SPACER INSTALL

49. Remove the factory 90 degree air fitting from the air line using a small screwdriver to release the clips. (Fig 28)

FIGURE 28



50. Remove the white plastic ferrule retainer on the provided fittings located in the rear box kit 022259 (Fig 29). Slide the fitting and ferrule on the end of one of the provided pieces of air line. (Fig 30) Leave approximately 1/16" of air line past the end of the ferrule to ensure it doesn't slide off when installing it into the air bag. Don't leave too much line sticking past the ferrule or it will prevent air flow into the bag.



Tip

If the supplied air lines are slightly crimped at the ends from being cut from the factory, cut off that section with a razor blade with a slight angle to ensure a good seal on the o-rings. There is more than enough length available.

FIGURE 29



FIGURE 30



Note: The tapered side of the ferrule goes towards the fitting as shown in Figure 30.

51. Attach the new air line to the top of the air spring and repeat the process for the opposite side air bag. Tighten to 44 in. lbs.
52. With the air lines installed, install the front air spring spacers (02776) with the original mounting hardware to the top of the air springs. Torque nuts to 30 ft-lbs.
53. Loosely install the air bag assemblies on the appropriate sides of the truck with the provided 10mm nuts and washers (BP 662) on the spacer studs.
54. Locate the 90 degree push-to connect air line fittings. Slide the OE air line clip down the line enough to clear the fitting and push the fitting on the OE line and to the provided line installed earlier on the air bag.



Caution

If the system has a leak, it may require a trip to a Ram dealer to have the system recharged. Use care to prevent any leaks. Verify both ends of the push to connect fittings are secure by pushing it on until it bottoms and then gently pulling to ensure it is sealed. The colored retainers should be pulled all of the way out from the fitting when properly attached.

55. Install the new driver's side steering knuckle to the lower control arm ball joint and loosely attach with the original nut. Install the driver's side CV axle in the hub and loosely fasten with the original axle nut. Swing the knuckle/CV assembly up while aligning the axle with the differential output shaft. Loosely attach the strut to the lower control arm with the original hardware. Push the CV axle all the way onto the differential output to seat the internal retaining clip.
56. Support the lower control arm with a hydraulic jack and attach the knuckle to the upper ball joint with the OE nut.
57. Torque the upper ball joint nut to 55 ft-lbs and the lower ball joint nut to 60 ft-lbs. Torque the axle nut to 185 ft-lbs. Torque the upper strut-to-frame nuts to 30 ft-lbs.
58. Repeat knuckle/CV installation on passenger's side.
59. Install the brake rotor and caliper on the knuckle/hub. Torque the OE caliper bolts to 130 ft-lbs. Use loctite on the caliper bolts.
60. Trim 1/2" from the male thread on the inner tie rod. Take care not to trim too much off from the male threads to ensure adequate tie rod thread engagement.
61. Locate the provided tie rod ends and replacement jam nuts and install them on the inner tie rod. Attach the tie rod ends to the new steering knuckles with the included nut. Torque to 55 ft-lbs. Securely lock off the jam nut. It is recommended to have approximately 2 threads left exposed past the jam nut for ease of alignment adjustment.
62. Reconnect the ABS wires at the frame.
63. Route the brake and ABS lines around the back side of the knuckle. Attach the brake line and ABS wire with 1/4" hardware and clamps (BP 662) to the threaded hole in the backside of the steering knuckle. Secure the ABS wire with zip ties at other locations to prevent any contact with rotating / moving parts. Ensure there is adequate slack and clearance between the brake line and suspension components. (Fig 31)

64. Install the sway bar link extension onto the factory sway bar link. Attach the assembly to the sway bar with the factory bushing, new cup washers, and 7/16" nylock nuts (BP 662) and Loctite on threads to attach to the factory sway bar link.. Tighten bolt until bushings begin to deform. It is NOT necessary to over tighten the bolt. Over tightening will cause premature bushing wear. (Fig 32)

FIGURE 31



FIGURE 32

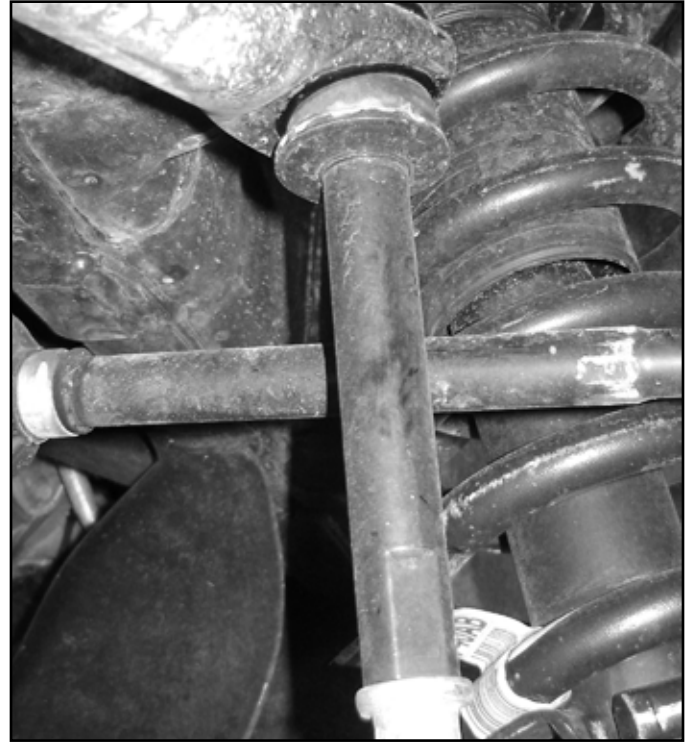

RAM REBEL FRONT RIDE HEIGHT SENSOR BRACKET INSTALLATION



Tip

These brackets are only necessary to install on the Ram Rebel to calibrate the front ride height so it will function in all ride height modes.

65. Remove the factory air ride sensor bracket from the frame and air ride sensor. This is located just ahead of the air bag mount on the frame.
Use care not to over rotate the sensor arm when it is disconnected from the bracket
66. Locate the provided sensor brackets and that mimic the factory bracket on each side. They are side specific.
67. Attach the sensor to the provided bracket on each side with the factory hardware.
68. Install the brackets to the frame with the factory bolts. (Figure 1)

FIGURE 1



REAR INSTALLATION INSTRUCTIONS

69. Park the vehicle on clean, flat, and level surface. Block the front wheels for safety.
70. Disconnect the rear trackbar from the axle, retain hardware.
71. Raise the rear of the vehicle and support the frame rails with jackstands.
72. Remove the wheels.
73. Support the axle with a hydraulic jack.
74. Remove the screws holding the inner fenders to gain access to the air bag fittings. (Fig 33)

FIGURE 33

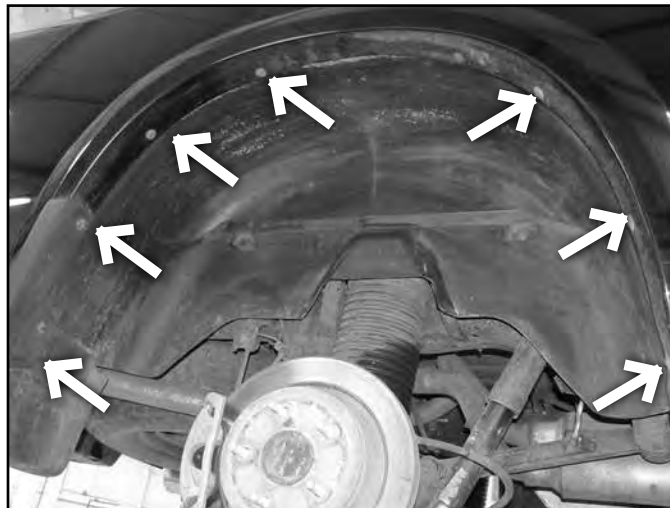

75. Using a wrench remove the air line fitting from the rear bags. Release the clips and remove the air bags from the vehicle. (Fig 34)

! Caution

Use care not to over extend the bags once removed. The best way to ensure the bags do not become unrolled from the ends internally is to release the pressure from the bags with some of the vehicle weight on them. Use care when doing so as the vehicles ride height will suddenly drop. The air lines to the rear can be disconnected at the distribution block on the passenger frame rail first.

FIGURE 34

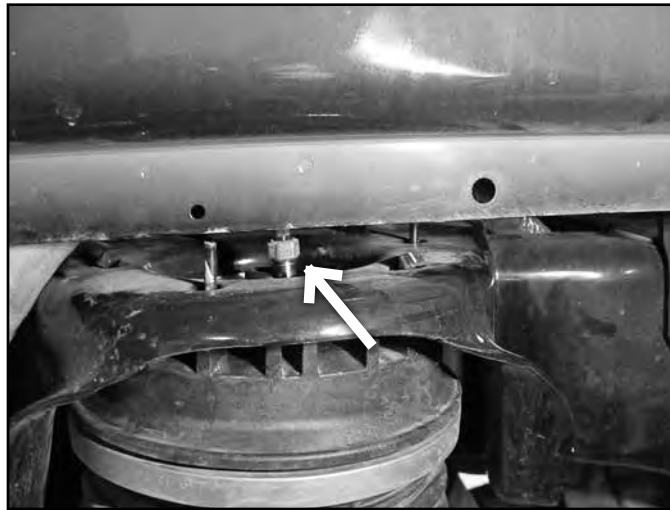

76. With the axle supported, remove the shocks. Retain the mounting hardware. (Fig 35)

FIGURE 35



77. Disconnect brake line brackets from the outside of the frame rails. Remove the ABS wires from the retaining clips.

78. Remove rear sway bar links (Fig 36).

FIGURE 36

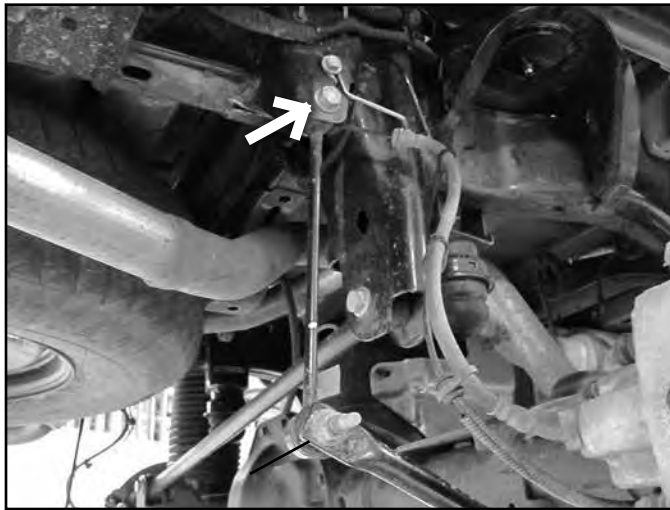

79. Disconnect the ride height sensors from the upper control arm (Fig 37).

FIGURE 37

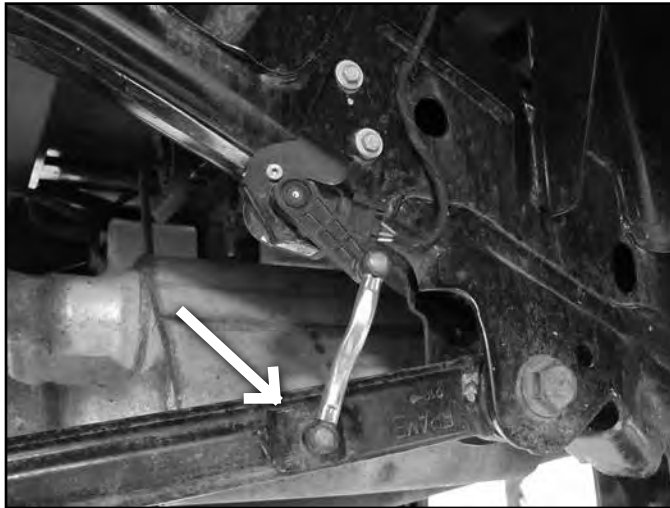

80. Disconnect the upper control arm from the axle. Loosen the upper control arm bolt at the frame rail, but do not remove. Retain hardware.
81. Place the upper control arm relocation bracket over the pocket. The plate will be offset towards the inside of the vehicle. The upper plate will only use 2 of the 4 holes that go from the top down. Mark the center of the holes and drill to 7/16". (Fig 38, 39a, 39b)

FIGURE 38 - PASSENGER SIDE

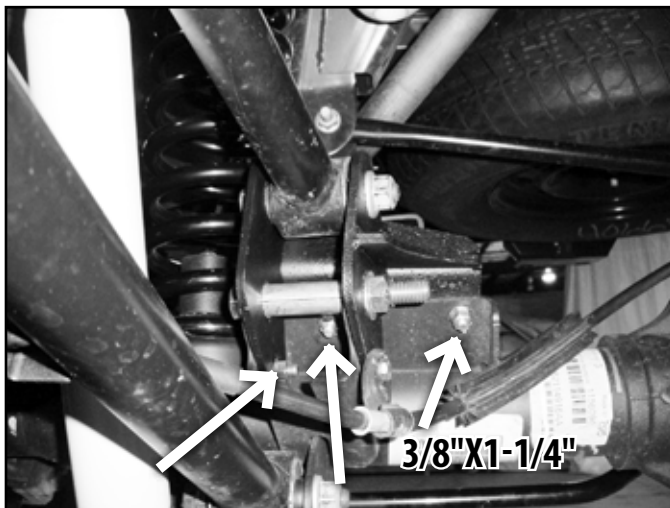

FIGURE 39A - DRIVER SIDE

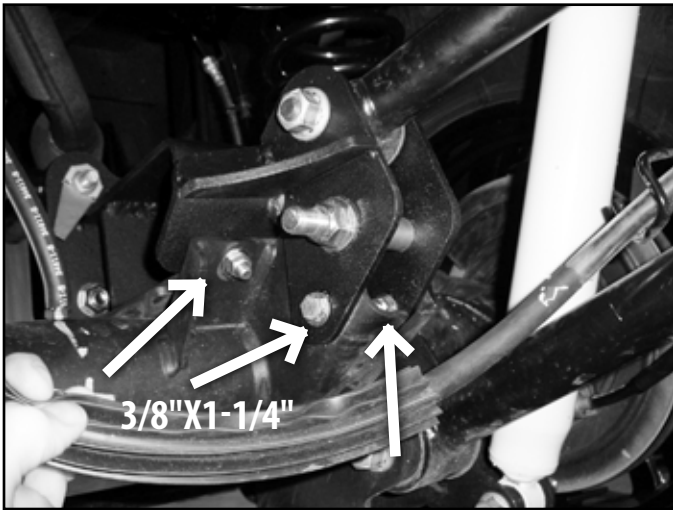
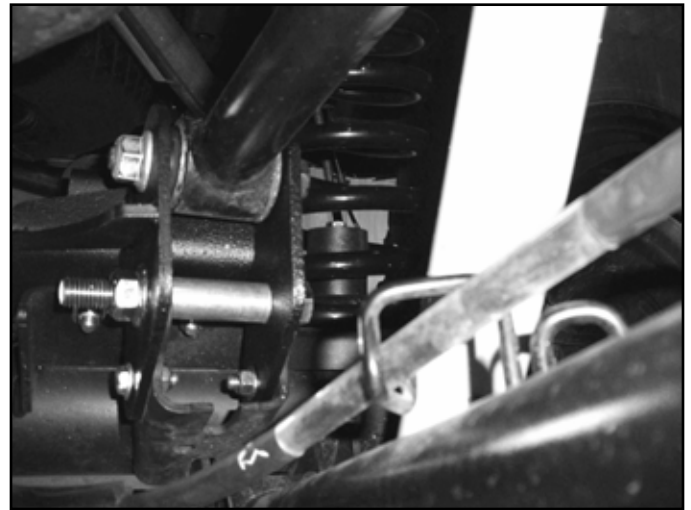

FIGURE 39B - DRIVER SIDE



82. The lower holes can be marked by offsetting the plate to the opposite side of the control arm pocket. Mark the lower hole centers and drill out to 7/16".
83. Attach relocation brackets with 3/8" x 1-1/4" bolts, washers, and nuts. The inside passenger hole will require the 8mm bolt and the tab on the e-brake cable bracket to be formed slightly for clearance. Use 5/8" x 4-1/2" bolt with crush sleeve through the original upper arm mounting hole. Hardware is located in bolt pack 813.
84. Install the upper arm with the OE bolt. Leave control arm hardware loose at this time. Tighten 8mm bolt to 25 ft-lbs, 3/8" hardware to 35 ft-lbs, and 5/8" hardware to 95 ft-lbs.
85. Re-connect the ride height sensor to the upper control arm.
86. Install the new rear shocks. Use new 9/16" x 3" bolts (BP 813) at the top mount with the new nut tabs (01290). Tighten shock hardware to 75 ft-lbs.

REAR AIR BAG INSTALLATION

87. The brass air fittings on the ends of the factory lines will need to be removed. Gently open the split in the ferrule to release it and slide it off of the air line. It's important to not scratch the OE line so it has a good seal on the provided fittings. If it does get scratched, cut that small section of line off.

FIGURE 40



88. Install the provided fitting and ferrule on the end of one of the provided pieces of air line like was done for the front air lines. Attach the new air line to the air bag (Fig 41).



Tip If the supplied air lines are slightly crimped at the ends from being cut from the factory, cut off that section with a razor blade with a slight angle to ensure a good seal on the o-rings. There is more than enough length available, cut the line to an appropriate length.

FIGURE 41



89. Drill out the holes in the frame where the stock air bag round locating studs went through using a 3/8" drill.
90. Attach the rear air bag spacers to the frame using the provided 5/16" nuts and washers (BP 457).
91. Install the rear air bags to the spacers. They will clip into place and will only install one way.
- 92.

! Caution

Before filling the air bags, it is important to temporarily remove the gaiter and verify the bag is still folded over BOTH ends. (Fig 42) If the bag has been overextended, the bag will need to be removed and compressed so the bag folds over both ends as shown. Leave gaiters loose so the bags can be checked again before the filling procedure.

FIGURE 42



💡 Tip

One way of getting the ends of the air bag seated properly is to apply a small amount of air pressure using an air nozzle while simultaneously compressing the bag until the bag folds evenly over both ends.

93. Locate the straight push to connect air line fittings and connect the factory air line to the provided air line attached to the air bag.

! Caution

If the system has a leak, it may require a trip to a Ram dealer to have the system recharged. Use care to prevent any leaks. Verify both ends of the push to connect fittings are secure by pushing it on until in bottoms and then gently pulling to ensure it is sealed. The colored retainers should be pulled all of the way out from the fitting when properly attached.

REAR TRACK BAR BRACKET & BUMP STOP EXTENSIONS

94. Attach the bump stop extensions to the driver and passenger side with 3/8" bolts and washers (BP 808) into the provided threaded plate. Tighten to 35 ft-lbs (Fig 42).
95. Place rear track bar bracket (02280B) over the original mount. Mark hole center to be drilled. Remove bracket and drill hole to 7/16".

96. Install the track bar bracket back on the factory mount. Fasten with the provided 9/16" hardware through the original track bar hole. Place the provided crush sleeve (109) in the factory bracket when installing the hardware. Attach bracket with 3/8" x 1-1/4" bolt, nuts and washers through the hole drilled in the previous step. Tighten 3/8" hardware to 35 ft-lbs and 9/16" to 95 ft-lbs. (Fig 43)

FIGURE 43

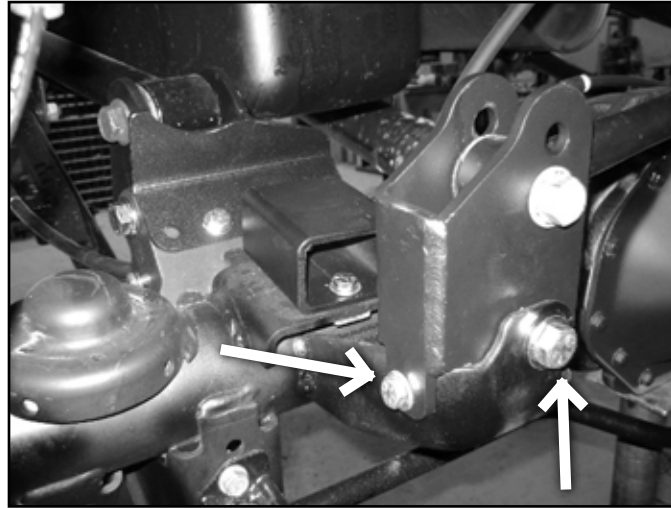

97. Install hourglass bushings into sway bar links. Install sleeves into bushings.
98. Install sway bar links (911103) on vehicle with 12mm x 60mm bolts, washers and nuts. They install to the inside of the mount. (BP 807) Tighten to 55 ft-lbs.
99. Install brakeline drop brackets on the outside of the frame rail at the sway bar mount. Attach brakeline to bracket with 1/4" x 3/4" bolt, washers, and nut (BP 813). Tighten to 20 ft-lbs.
100. Reattach ABS wire to clips on brakeline.

FINAL INSTALLATION STEPS

101. Remove the stock CV boot clamp on the front driveshaft at the transfer case. Slide the boot rearward approximately 1/4" and install the new boot clamp, rotate the driveshaft to ensure that the clamp does not interfere with the lip on the front driveshaft. (Fig 44a, 44b)

FIGURE 44A



FIGURE 44B



102. Install wheels and lower vehicle to the ground. Torque the lug nuts to 135 ft-lbs.
103. Verify the rear air bags are properly seated on the axle and the ends of the bags are folded over both ends. (Figure 42 - previous page)

! Caution

Failure to ensure the bags are seated and folded over both ends can result in damage to the air bag or personal injury when pressurizing the system.

104. Using a jack or hoist raise the rear of the vehicle to a ride height of approx. 23" from the center of the wheel to the fender. This is done to help reduce any pinched areas in the rear air bag. Check the bag for any pinched areas and adjust the jack to reduce these while keeping the bags engaged to the axle and folded over both ends.
105. Reconnect the battery and enable the air ride system under the vehicles control panel. The air suspension system will return to normal operation when the vehicle reaches 15 mph.
106. Tighten upper control arm hardware to 120 ft-lbs.
107. Install rear trackbar into the lower hole in the relocation bracket with OE bolt and nut. Tighten to 95 ft-lbs.
108. Re-install inner fender liners with factory screws.
109. Center the lower cams and torque lower control arm hardware to 125 ft-lbs. Torque the strut-to-lower control arm bolt to 125 ft-lbs.
110. Since the front brakelines were disconnected the brakes must be bled before driving vehicle. Also do a final check to ensure the brake lines will not contact the tire or other moving components.
111. Check all fasteners for proper torque. Recheck all fasteners after 500 miles and at regularly scheduled maintenance intervals.
112. A complete front end alignment is required. Do not drive the vehicle with the steering wheel off center. This can cause unsafe driving conditions.

POST INSTALLATION NOTES

1. Recheck all fasteners for proper torque. Check again after 500 miles and at regularly scheduled intervals.
2. If the air suspension system is giving error messages or is not leveling the vehicle, most likely a leak is present. Check all of the push to connect fittings as well as the screw in fittings installed on the new air lines with soapy water to check for leaks.

AIR SYSTEM TROUBLESHOOTING INFORMATION

1. To reset the air suspension module, press the terrain select "Up" and "Down" switches simultaneously for more than 5 seconds. This will disable the air suspension. Driving the vehicle 15 mph will return the system to normal operation.
2. According to Ram, the air bags can be removed up to 5 times without having a leakage concern, however in the event that the air suspension is not functioning correctly, it may be necessary to fill the system using a scan tool under the Air Suspension Control Module (ASCM) routines. This can typically only be accessed by a Ram dealer scan tool.



WE WANT TO SEE YOUR RIDE!

Grab photos of your BDS-equipped truck in action and send them in for a chance to be featured. Send it in to our Bad Ass Rides customer gallery at bds-suspension.com/bar and post them on the BDS Fan Page on Facebook at facebook.com/BDSSuspensions. Don't forget about your BDS swag! BDS offers t-shirts, hoodies, decals and more available on the BDS website or through your local BDS distributor.

TIME TO HAVE SOME FUN

Thank you for choosing BDS Suspension.

For questions, technical support and warranty issues relating to this BDS Suspension product, please contact your distributor/installer before contacting BDS Suspension directly.