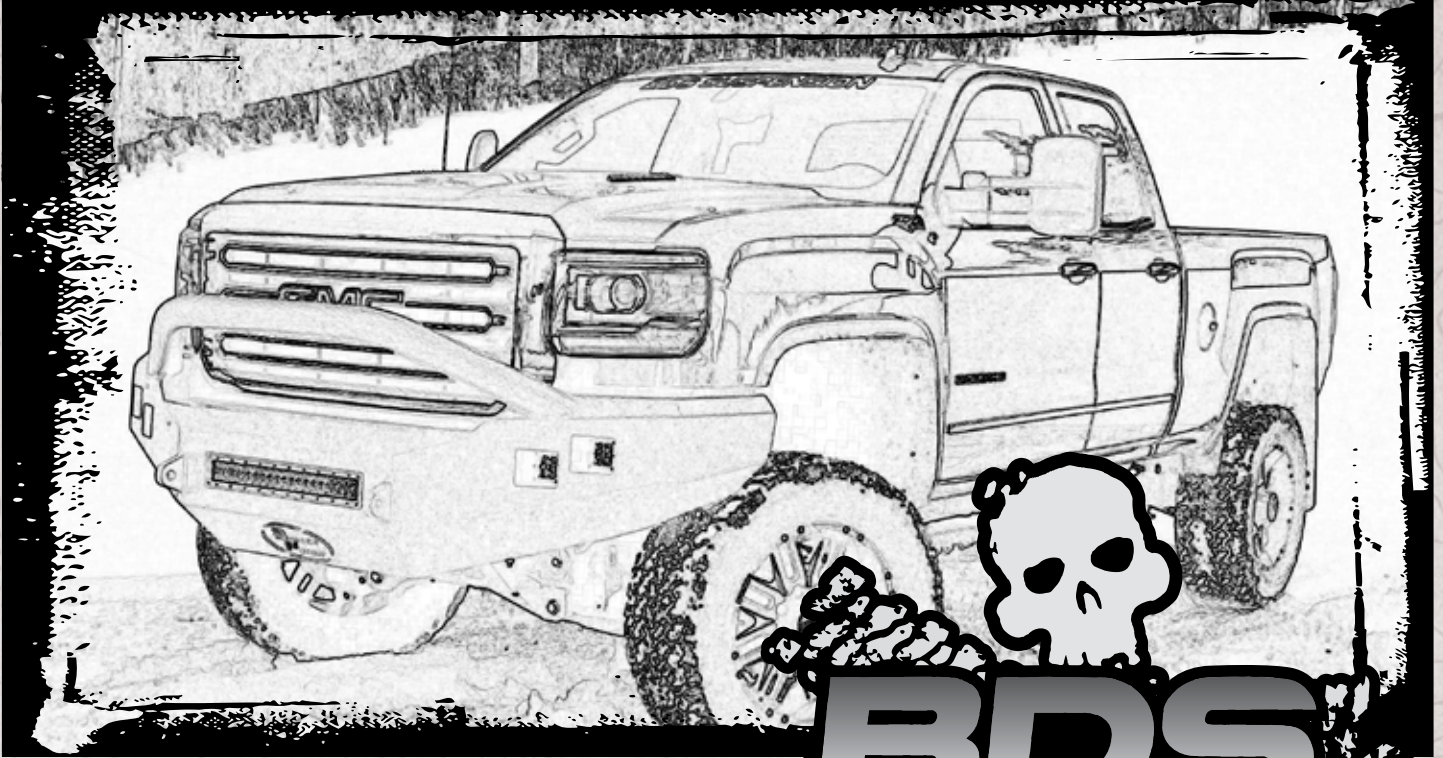
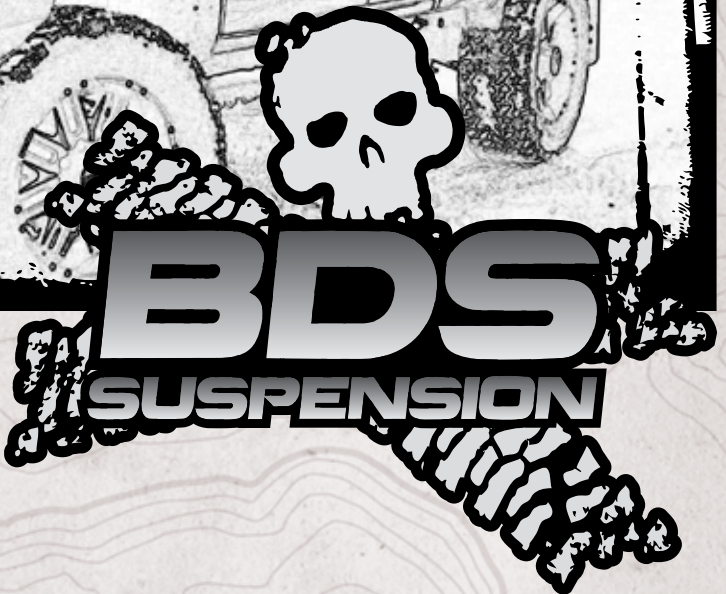


# INSTALLATION GUIDE



Part#: 021253



**HARDCORE LIMITED LIFETIME WARRANTY**

## 2.5" Coilover Conversion System

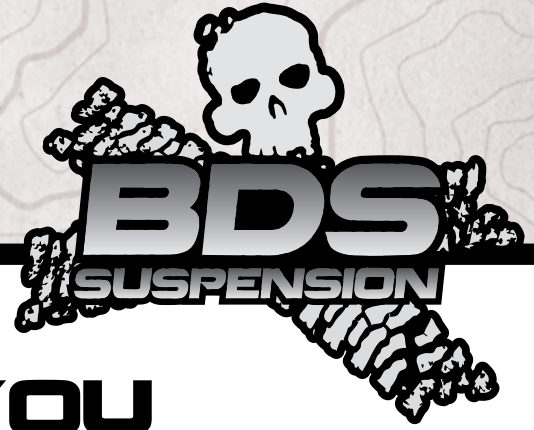
**Chevy/GM 2500/3500 HD Pickup 2WD/4WD | 2011-2019**

Rev. 112119

491 W. Garfield Ave., Coldwater, MI 49036 • Phone: 517-279-2135

Web: [www.bds-suspension.com](http://www.bds-suspension.com) • E-mail: [tech-bds@ridefox.com](mailto:tech-bds@ridefox.com)

# Read And Understand All Instructions And Warnings Prior To Installation Of System And Operation Of Vehicle.



## THANK YOU

Your truck is about to be fitted with the best suspension system on the market today. That means you will be driving the baddest looking truck in the neighborhood, and you'll have the warranty to ensure that it stays that way for years to come. Thank you for choosing BDS Suspension!

### BEFORE YOU START

BDS Suspension Co. recommends this system be installed by a professional technician. In addition to these instructions, professional knowledge of disassembly/ reassembly procedures and post installation checks must be known.

### FOR YOUR SAFETY

Certain BDS Suspension products are intended to improve off-road performance. Modifying your vehicle for off-road use may result in the vehicle handling differently than a factory equipped vehicle. Extreme care must be used to prevent loss of control or vehicle rollover. Failure to drive your modified vehicle safely may result in serious injury or death. BDS Suspension Co. does not recommend the combined use of suspension lifts, body lifts, or other lifting devices. You should never operate your modified vehicle under the influence of alcohol or drugs. Always drive your modified vehicle at reduced speeds to ensure your ability to control your vehicle under all driving conditions. Always wear your seat belt.

### BEFORE INSTALLATION

- Special literature required: OE Service Manual for model/year of vehicle. Refer to manual for proper disassembly/reassembly procedures of OE and related components.
- Adhere to recommendations when replacement fasteners, retainers and keepers are called out in the OE manual.
- Larger rim and tire combinations may increase leverage on suspension, steering, and related components. When selecting combinations larger than OE, consider the additional stress you could be inducing on the OE and related components.
- Post suspension system vehicles may experience drive line vibrations. Angles may require tuning, slider on shaft may require replacement, shafts may need to be lengthened or trued, and U-joints may need to be replaced.
- Secure and properly block vehicle prior to installation of BDS Suspension components. Always wear safety glasses when using power tools.
- If installation is to be performed without a hoist, BDS Suspension Co. recommends rear alterations first.
- Due to payload options and initial ride height variances, the amount of lift is a base figure. Final ride height dimensions may vary in accordance to original vehicle attitude. Always measure the attitude prior to beginning installation.



Visit [560plus.com](http://560plus.com) for more information.

### TIRES AND WHEELS

2.5" Kit:

35x12.50 on 9" wide wheels with 5" of backspacing -  
trimming / inner fenderwell modification required.

Wider wheels or wheels with less backspacing will require a  
smaller tire or increased trimming.

### BEFORE YOU DRIVE

Check all fasteners for proper torque. Check to ensure for adequate clearance between all rotating, mobile, fixed, and heated members. Verify clearance between exhaust and brake lines, fuel lines, fuel tank, floor boards and wiring harness. Check steering gear for clearance. Test and inspect brake system.

Perform steering sweep to ensure front brake hoses have adequate slack and do not contact any rotating, mobile or heated members. Inspect rear brake hoses at full extension for adequate slack. Failure to perform hose check/ replacement may result in component failure. Longer replacement hoses, if needed can be purchased from a local parts supplier.

Perform head light check and adjustment.

Re-torque all fasteners after 500 miles. Always inspect fasteners and components during routine servicing.

# CONTENTS OF YOUR KIT

## BDS021251 LCSA Box Kit - DRV

Part #	Qty	Description
A256	1	LCA Assembly - DRV
02832	1	2011 Chevy HD LCA - DRV
K500232	1	Lower Ball Joint (Moog)
MB08B700720	1	Rear Lower Bushing
MB08B700710	1	Front Lower Bushing
02899	2	BDS Large Logo
B56X012BH	2	Stainless Button Head Bolt

## BDS021252 LCA Box Kit - PASS

Part #	Qty	Description
A257	1	LCA Assembly - PASS
02833	1	2011 Chevy HD LCA - PASS
K500232	1	Lower Ball Joint (Moog)
MB08B700720	1	Rear Lower Bushing
MB08B700710	1	Front Lower Bushing
02899	1	BDS Large Logo
B56X012BH	2	Stainless Button Head Bolt

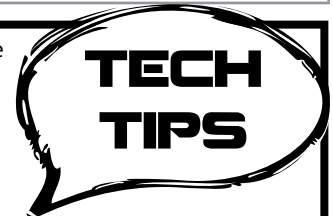
## BDS121250 - UCA Box Kit

Part #	Qty	Description
A258	1	UCA Assembly - DRV
02836	1	2011 Chevy HD UCA - DRV
500-1104	1	Ball Joint
02839	2	Bushing - UCA
02911	1	Aluminum Cap - Anodized
9452K145	1	O-ring (#139)
A259	1	UCA Assembly - PASS
02837	1	2011 Chevy HD UCA - PASS
500-1104	1	Ball Joint
02839	2	Bushing - UCA
02911	1	Aluminum Cap - Anodized
9452K145	1	O-ring (#139)

## BDS021253 - Front Box Kit

Part #	Qty	Description
02834	1	Upper C/O Mount - DRV
02835	1	Upper C/O Mount - PASS
02912	1	Weld-in Support Gusset - DRV
02913	1	Weld-in Support Gusset - Pass
02838	1	Reservoir Mount - DRV
02919	1	Reservoir Mount - Pass
911124	2	3" Lift Sway Bar Link
SB35BK	2	Wide Eb1 Bushing
SB26RB	4	Sway Bar Link Stem Bushing
54587	2	3/4" OD x 1.575" x 9/16" ID Sleeve
954	1	Bolt Pack - Mounting Hardware
	2	1/2"-13 x 1-1/4" Bolt - Grade 8
	4	1/2"-13 x 1-1/2" Bolt - Grade 8
	2	1/2"-13 x 3-1/4" Bolt - Grade 8
	2	1/2"-13 x 4-1/4" Bolt - Grade 8
	20	1/2" SAE Thru-Hardened Washer
	10	1/2"-13 Prevailing Torque Nut
955	1	Bolt Pack - Sway Bar Links
	2	7/16"-14 Nylock Nut
	4	7/16" USS Washer - Grade 9
	2	9/16"-12 x 3" bolt - grade 8
	4	9/16" SAE Thru-hardened washer
	2	9/16"-12 Prevailing Torque Nut
73	2	0.875" Diff Spacer Sleeve - Frt
75	2	0.425" Diff Spacer Sleeve - Rear
679	1	Bolt Pack - Diff Drop Hardware
	2	9/16"-12 x 5" bolt - grade 8
	2	9/16"-12 x 5-1/2" bolt - grade 8
	8	9/16" SAE thru hardened Washer
	4	9/16"-12 Prevailing Torque Nut
B14X34G5	2	1/4" x 3/4" self threading bolt
BDS222763	1	1" x 10" Brushed Decal
	4	Zip Ties

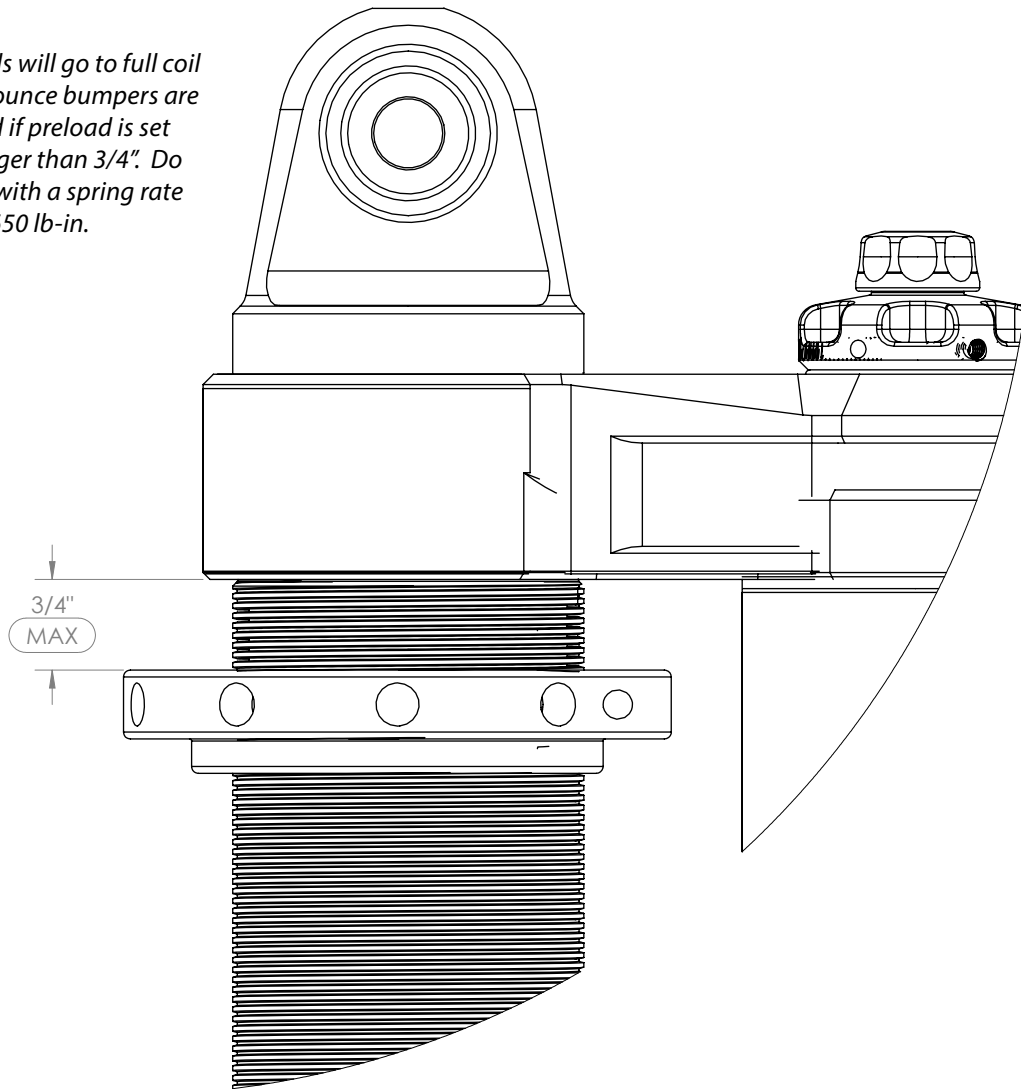
- Disassembly/assembly of the factory torsion bar system requires the use of a special unloading tool. The GM specified tool # is CH48809.
- Some minor trim will be required with certain wheel/tire combination. This is normal with most aftermarket tire/wheel fitment on Chevy/GM trucks. Trimming will normally included the bottom edge of the inner fender shrouds and/or lower corner of front bumper valance. As a rule of thumb, deeper backspacing and shorter/narrower tires will reduce/eliminate trimming required.
- Coilovers are set for 2.5" lift on diesel models and are not recommended for gas models due to providing too much lift. Do not set the coilovers to have over 3/4" of exposed thread above the upper mount. A coil spring compressor is highly recommended, there is a LOT of preload in these coils.
- This is a performance kit, designed for a stock vehicle weight. Heavy plate steel front bumpers are not recommended, aftermarket tube bumpers will typically work well with this system.
- Ball joint used is 500-1104, use this for replacement purposes if a new ball joint is ever needed. Ball joint is directional and must be installed with the 'dot' facing either inward or outward on the vehicle, otherwise damage may occur.



# INSTALLATION INSTRUCTIONS



**Tip** Coils will go to full coil bind before jounce bumpers are fully engaged if preload is set at a value larger than 3/4". Do not use coils with a spring rate higher than 650 lb-in.



## FRONT INSTALLATION

1. Park the vehicle on a flat, clean surface and block the rear wheels for safety.
2. Disconnect the battery / batteries on the truck. Do not weld with the batteries hooked up.
3. Raise the front of the vehicle and support with jack stands under the frame rails.
4. Remove the wheels.
5. Unload the torsion bars by removing the torsion bar adjusting bolt (Fig 1). Use special torsion bar unloading tool to remove the bridge below the torsion key from the vehicle. There should be no pressure on the torsion bar at this time.

## SPECIAL TOOLS

1-1/2" (38mm) socket/wrench  
34mm socket  
T30 Torx bit  
1-1/16" (27mm) socket/wrench  
Torsion Bar Unloading tool (see Pre-Installation Note #2)  
Reciprocating Saw  
4" Cut-off Wheel/Tool (optional)  
Pair of Large (8-10") C-Clamps

**FIGURE 1**



**Tip** Torsion bars are under extreme pressure. A proper torsion bar tool is necessary to unload the bars. A tool designed specifically for GM torsion bars is required see troubleshooting note #1.

6. Remove the torsion bar keys by pushing the torsion bar forward to allow the key to drop free. On some vehicles this will require using a hammer/punch or air hammer. Access the end of the torsion bar through the hole in the back of the torsion bar crossmember and drive forward. Leave the torsion bars in the lower control arms.
7. Remove the two bolts that attach the torsion bar crossmember to the frame rails (Fig 2A). Remove the torsion bar crossmember from the vehicle. Save bolts and crossmember. On diesel models, disconnect the wire on the passenger's side of the crossmember before removing (Fig 2B)

**FIGURE 2A**

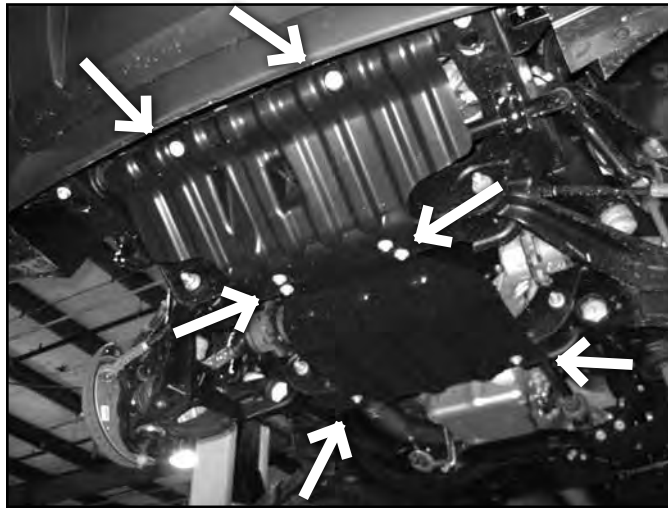


**FIGURE 2B**



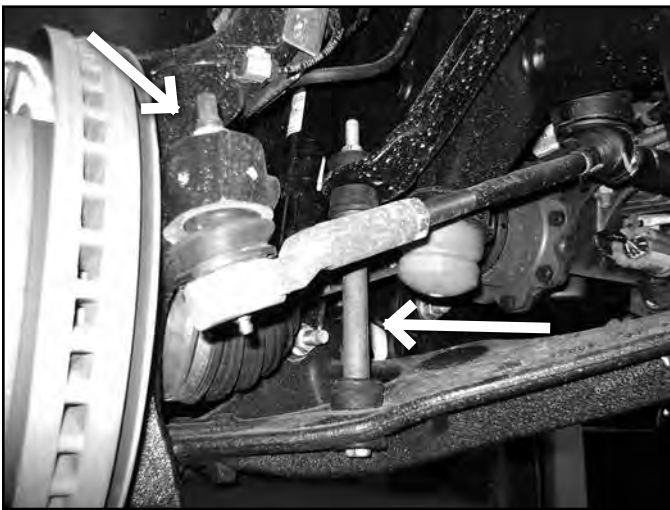
8. Remove the torsion bars by pulling them rearward out of the lower control arms. Set the torsion bars aside.
9. Remove the front plastic splash guard, save splash guard bolts. If equipped, remove the four bolts mounting the factory belly pan to the frame. The belly pan, if equipped can be reinstalled at the end of installation (Fig 3).

**FIGURE 3**



10. Disconnect the sway bar end links from the sway bar and the lower control arms (Fig 4A). Discard the link assemblies.
11. Disconnect the tie rod ends from the steering knuckles (Fig 4A). Remove the tie rod end nuts and save. Strike the knuckle near the tie rod end to dislodge the tie rod end taper (Fig 4B). Remove the tie rod ends from the knuckles.

**FIGURE 4A**

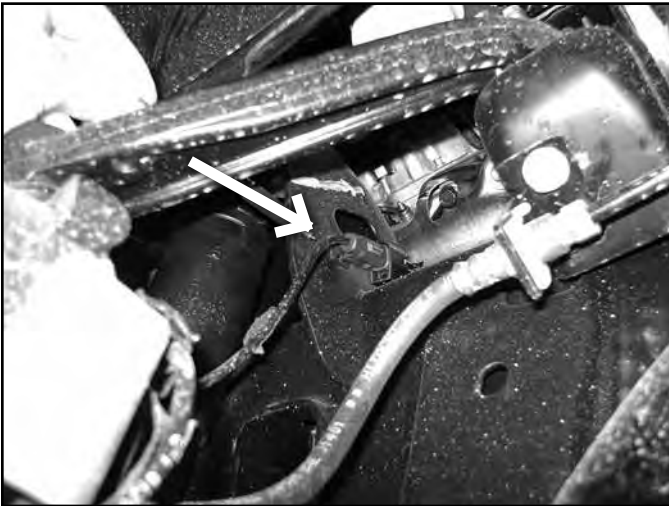


**FIGURE 4B**

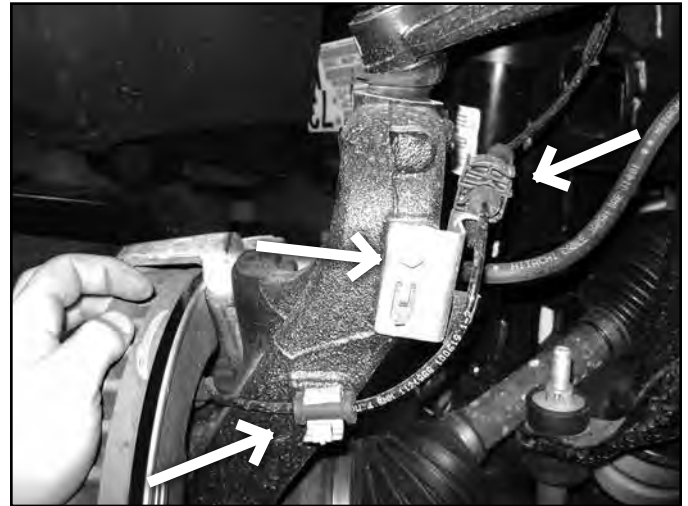


12. Disconnect the ABS brake wire from the connector at the frame (Fig 5) Remove the wire from the plastic retainers on the frame and brake line bracket on the steering knuckle (Fig 6).
13. Disconnect the rubber brake line bracket from the steering knuckle (Fig 6).

**FIGURE 5**



**FIGURE 6**



14. Remove the two bolts mounting the brake caliper assembly to the steering knuckle and hang the caliper out of the way (Fig 7). Do not hang the caliper by the brake hose. Save mounting bolts.

**FIGURE 7**

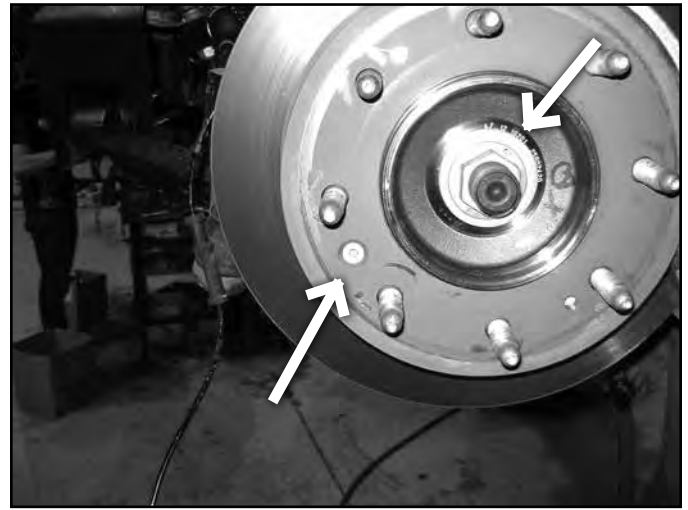


15. Carefully remove the hub dust cover. Save cover (Fig 8). Tip: Carefully work the cover loose with a small chisel.
16. Remove the rotor retaining bolt using a T30 torx bit (Fig 9). Remove the brake rotor and set aside. Save retaining bolt.
17. Remove the CV axle nut and washer (Fig 9). Save hardware.

**FIGURE 8**



**FIGURE 9**



18. Remove the upper and lower ball joint nuts (Fig 11). Reinstall the nuts a couple of turns by hand. Strike the knuckle near the ball joints to release the taper. Remove the nuts and remove the steering knuckle with the hub assembly from the vehicle. Save nuts. Take care not to strike the ball joint.

**FIGURE 11**



19. Remove the CV axle flange bolts at the differential (Fig 12). There are 8 bolts per side. Remove the CV shafts from the vehicle and set aside. Save bolts.

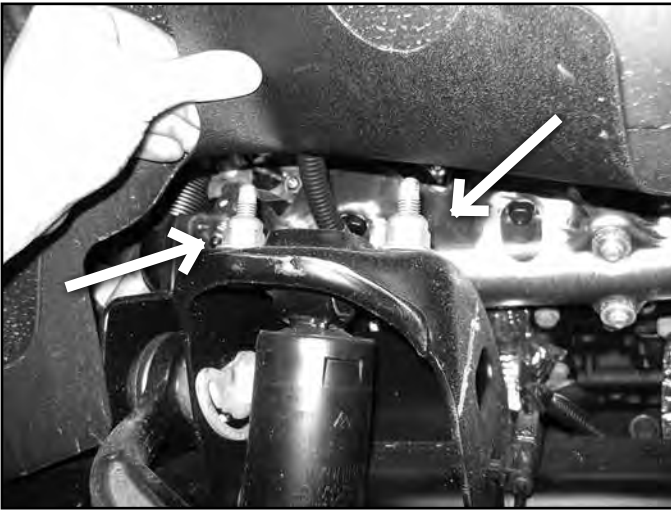


**FIGURE 12**

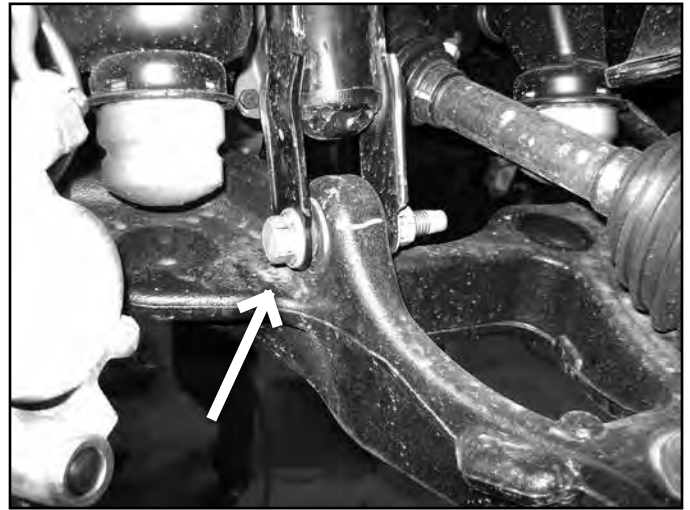


20. Disconnect the shocks from the frame (Fig 13A) and lower control arm (Fig 13B). Remove shocks. Save the lower shock mount hardware.

**FIGURE 13A**

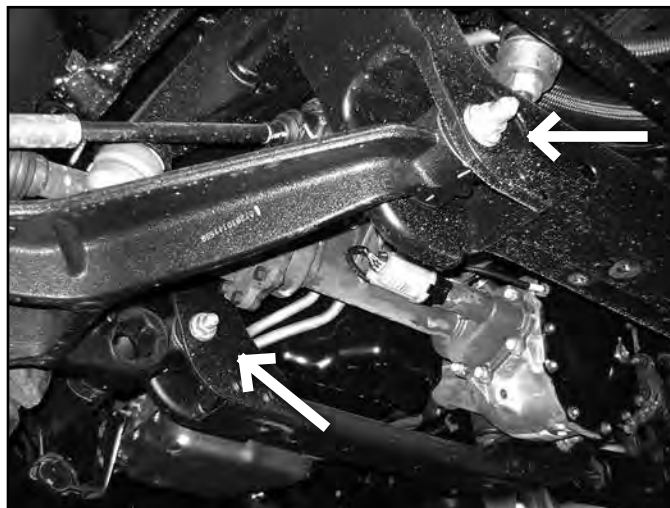


**FIGURE 13B**



21. Remove the front and rear lower control arm bolts and remove the lower control arms from the vehicle (Fig 14) Save the control arm mounting hardware.

**FIGURE 14**

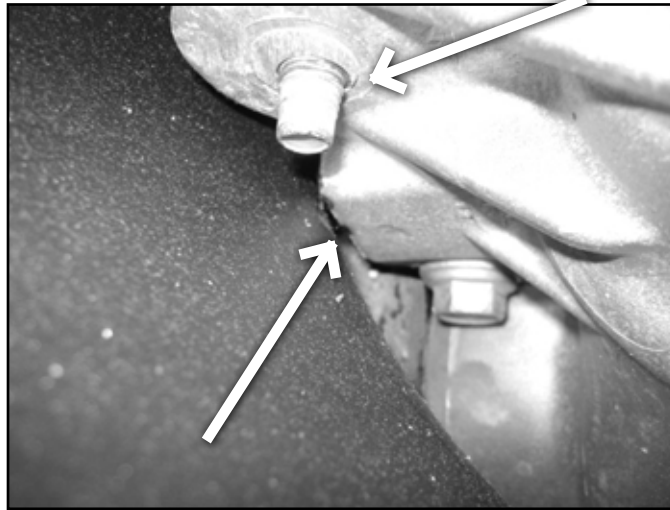


22. Remove the upper control arm from the vehicle. Save all of the cam bolts, cam washers, and nuts.

### DIFFERENTIAL DROP

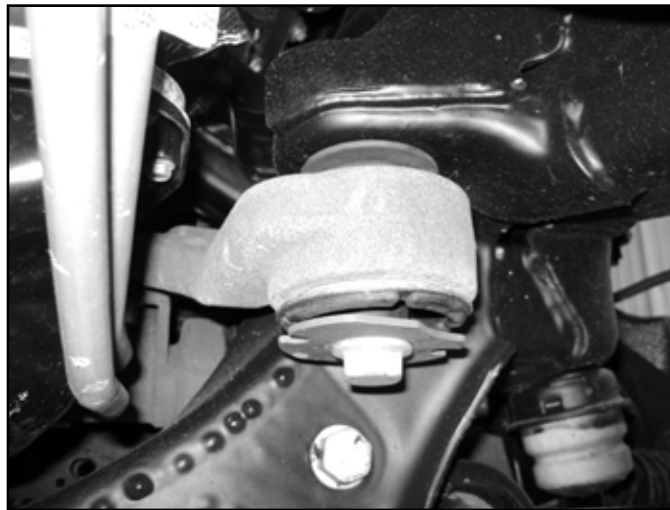
23. The differential area on the driver's side will need to have a small chamfer ground into it for clearance when the differential is lowered. Locate the area shown and use a rotary die grinder tool to put a small 1/4" wide chamfer onto the differential, not much material is required to be removed (Fig 15).

**FIGURE 15**



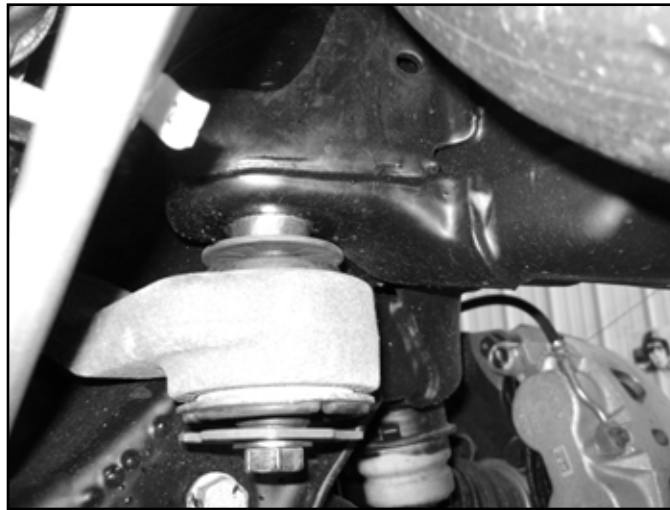
24. Work on one side of the vehicle at a time. Remove the hardware that attaches the differential mounts to the frame (Fig 16).

**FIGURE 16**



25. Lower the differential and install the spacers between the frame mounting points and the factory brackets. Use the short spacer at the rear mount with 9/16" x 5" hardware. Use the tall spacer at the front mount with 9/16" x 5-1/2" hardware (Fig 17).

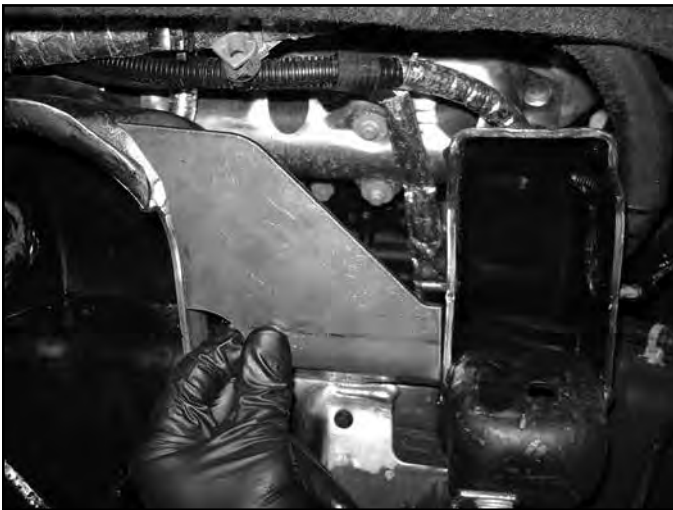
**FIGURE 17**



**CONTROL ARM AND COILOVER BRACKET INSTALLATION**

26. Prep the area by the upper shock mount for welding. Remove the GM undercoating in this area. Using brake clean with a putty knife is the easiest way to remove large chunks of the undercoating.
27. Place the weld-in support plate against the factory brackets. Ensure area is properly prepared for welding. Weld plate with appropriate mig or tig welder, certified welder highly recommended. (Fig 18a, 18b)

**FIGURE 18A**



**FIGURE 18B**



28. Allow plate to cool, coat bare metal with paint.
29. Install the upper control arms at this time (#02836 - DRV, #02837 - Pass). Use the factory cam bolts, washers, and nuts. Do not torque to specification at this time. Center the cams and snug hardware.
30. Place the upper coilover bracket against the factory shock mounting bracket. Mark center of the lower slot and drill out to 1/2". Driver's side will be an existing hole that needs to be enlarged. (Fig 19a, 19b)

**FIGURE 19A**



**FIGURE 19B**



31. Install the upper coilover bracket with 1/2" x 1-1/2" hardware through the original upper mount, attach the reservoir bracket to the top side. Attach lower hole with 1/2" x 1-1/4" hardware (BP # 954) . Tighten to 65 ft-lbs.
32. Install the coilover at this time. Attach to the upper bracket with 1/2" x 3-1/4" hardware. Note: Fitting will face towards the FRONT of the vehicle. (Fig 20)

**FIGURE 20**



33. Route the hose below the upper control arm and ABOVE the brake line. Attach the reservoir to the mount with included hose clamps. Ensure that the hose will not contact anything at full droop.
34. Install new lower control arms with factory hardware. Do not tighten the hardware at this time.
35. Attach the lower control arm to the lower coilover mount with 1/2" x 4-1/4" hardware. (Fig 21)

**FIGURE 21**



36. Reinstall the factory steering knuckle to the new lower control arm with the included nut.
37. Install the CV shaft into the hub assembly, do not attach to the differential at this time.
38. Raise and support the lower control arm. Attach the tie rod end to the steering knuckle with factory nut.
39. Swing the knuckle and CV assembly up and attach the upper ball joint and insert CV shaft into the differential assembly.
40. Attach CV to differential with factory 10mm hardware with loc-tite. Tighten to 40 ft-lbs.
41. Tighten the CV nut with 34mm socket to 177 ft-lbs. Reinstall the dust cap.
42. Torque remaining hardware as follows:

Upper ball joint nut - 37 ft-lbs Align castellated nut and install cotter pin.

Lower ball joint nut - 37 ft-lbs then turn an additional 95 degrees (just over 1/4 turn). Align castellated nut and install cotter pin.

Tie rod nut - 44 ft-lbs.

Coilover mounting hardware - 65 ft-lbs.

**FINAL FRONT STEPS:**

43. Reinstall the brake rotors with flat head torx bolt.
44. Reinstall the brake calipers with loc-tite on factory hardware. Tighten to 125 ft-lbs.
45. Reattach the brake line bracket to the steering knuckle with factory hardware. Bend the stock brakeline bracket to get the bracket to clear the coilover. (Fig 22)

**FIGURE 22**



46. Reinstall the torsion bar cross-member with factory hardware. Reconnect the exhaust sensor plug. Attach the clip to the cross-member.

47. Grease and install bushings and sleeves into the sway bar links.
48. Install sway bar links (911124) into the truck with 9/16" lower hardware. Use 7/16" washers, bushings (SB12BK), and 7/16" nylock nut (#955) to attach to the sway bar. Tighten 9/16" hardware to 65 ft-lbs, tighten upper nut until the bushings begin to swell. (Fig 23)

**FIGURE 23**



49. Reattach the ABS sensor plugs next to the upper coilover mount. Use zip tie to retain wire from flopping around.
50. Reinstall skid plate and splash shield with factory hardware.
51. Grease ball joint(s) at this time.
52. Install O-ring onto the ball joint cap. Use the included grease packet to lightly grease the o-ring and insert into the upper control arm. Press and twist the cap to get it to pop into the upper control arm. (Fig 24)

**FIGURE 24**

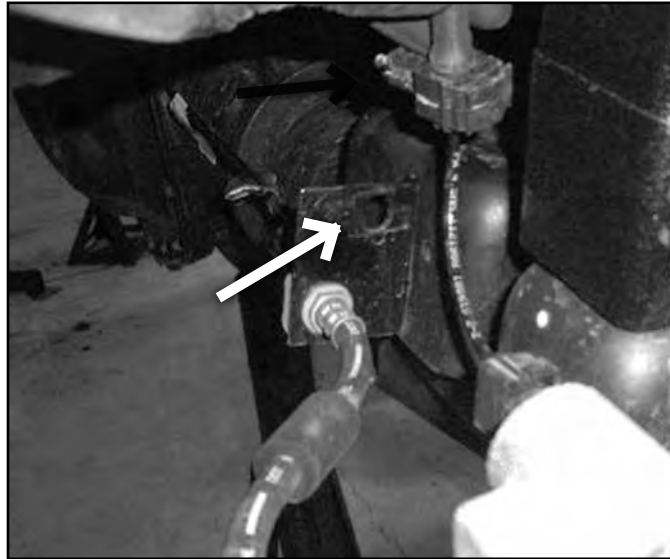


53. Note: Use a large flat blade screw driver to remove the upper ball joint cap to access the grease fitting during service intervals.
54. Cycle steering to ensure that all parts have enough clearance / slack and there is no interference.
55. Install the front wheels. Torque the lug nuts to 140 ft-lbs. Lower the vehicle to the ground.
56. Repeat steering sweep to ensure that all parts have enough clearance / slack and there is no interference.
57. Bounce the front end to settle the suspension.
58. Torque the lower control arm bolts (4) to 250 ft-lbs.
59. Torque upper control arm hardware (4) to 192 ft-lbs.
60. Check all front hardware for proper torque.
61. Check tire/wheel clearance with the fenders/bumper as well as with the steering knuckle. It is not uncommon to trim the lower plastic valance of the bumper and inner fender shroud slightly to add proper tire clearance while turning.

## REAR INSTALLATION

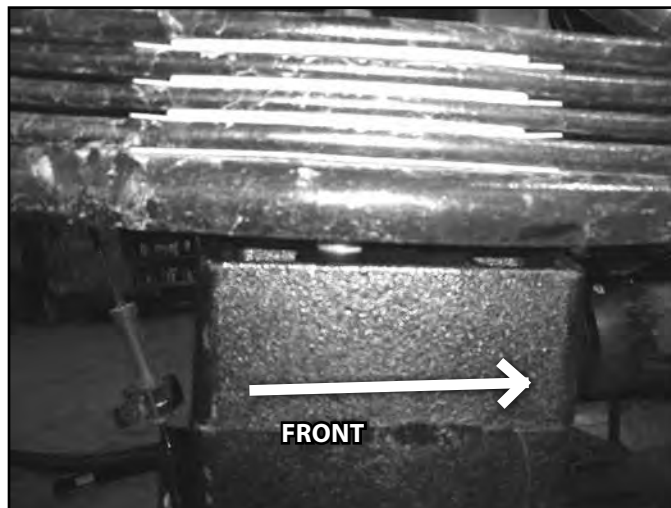
1. Block the front wheels for safety. Raise the rear of the vehicle and support with jack stands under the frame rails, just ahead of the front leaf spring hangers.
2. Remove the wheels.
3. Raise rear of vehicle and support frame with jackstands.
4. Support the rear axle with a hydraulic jack.
5. Push the ABS wire clips from the metal tabs just inside of the leaf springs. Remove the plastic clips from the ABS wire.(Fig R1)

**FIGURE R1**



6. Remove the rear shocks. Save hardware.
7. With the axle well supported, remove the passenger's side u-bolts and lower u-bolt plate. Loosen, but do not remove the u-bolt hardware on the driver's side. This will allow the axle to move more easily and aid in installation. Check e-brake cables for proper slack, remove them from factory hangers to gain additional travel if necessary.
8. Lower the axle to allow the lift block to be installed. The short end of the block will go towards the front of the vehicle. (Fig R2)

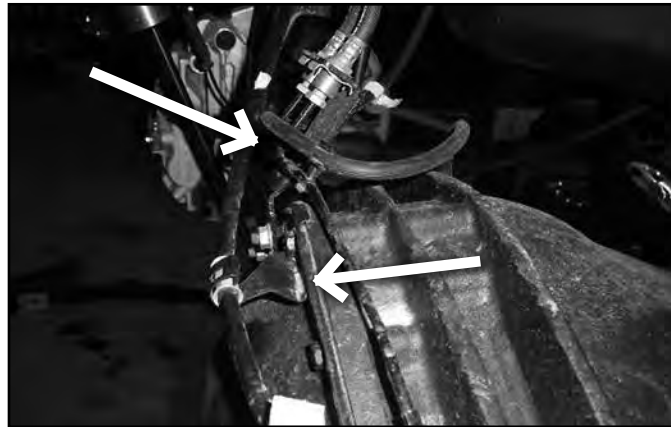
**FIGURE R2**



9. Attach axle to springs with new u-bolts.
10. Repeat block installation for driver's side.

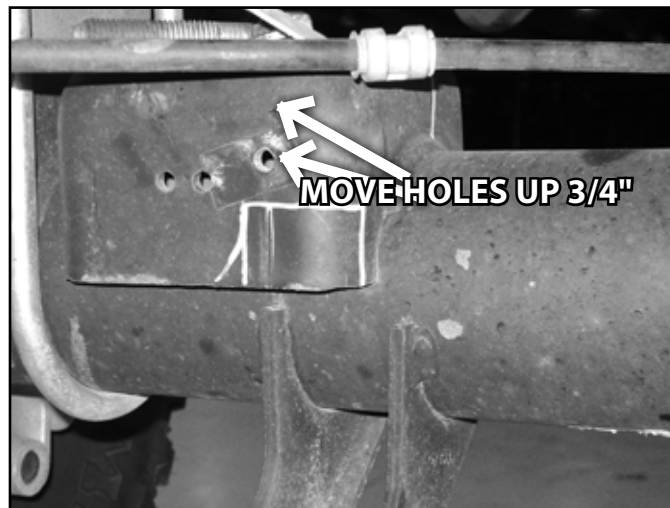
11. Carefully form the brake bracket at the axle to point up at approximately 45 degrees. Bend the e-brake cable bracket at the top of the differential to give enough slack at full droop. (Fig R3)

**FIGURE R3**



12. Check all cables for adequate slack at full droop, make adjustments if necessary. Extra zip ties are included to secure the e-brake cables together to keep them in place.
13. Install new rear shocks with factory hardware. Tighten hardware to 65 ft-lbs. Optional 2.5" SHOCK - NOTE: The axle bump stop pads will need to be trimmed for proper clearance of the larger-than-factory shock body as well as relocation of the e-brake cable bracket on the passenger's side. Measuring from the bottom inside corner of the pad (near the shock mount), make cut marks 1" up from the bottom and 1-1/4" outward from the inside edge. Also measure back from the front face 3/8". (Fig R4) Cut the square section out with a cut-off tool. Paint exposed metal. The e-brake bracket will need to be relocated up 3/4". Transfer the holes up 3/4" and drill to 7/32". Reattach the bracket with new 1/4" x 3/4" self threading bolt.

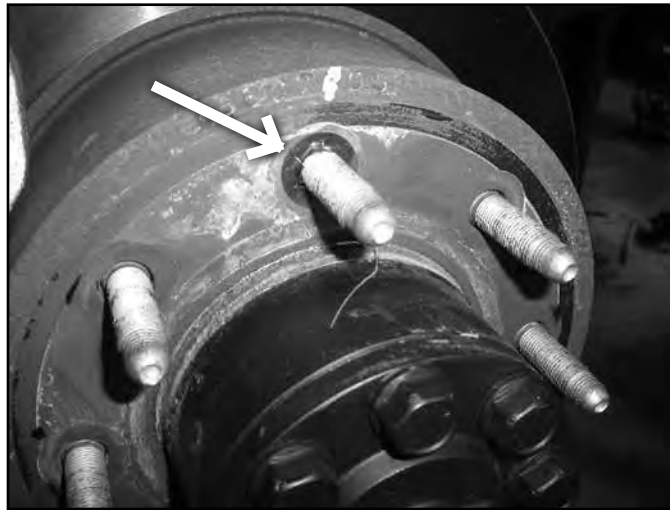
**FIGURE R4**



14. Remove clips on wheels (Fig R5). Reinstall wheels and lower vehicle to the ground. Torque u-bolts to 125 ft-lbs. Torque lug nuts to 140 ft-lbs.



**FIGURE R5**



## **POST-INSTALLATION**

1. Check all hardware for proper torque.
2. Reconnect the positive and negative battery cables.

## **FINAL CHECK**

3. The vehicle will need a complete front end alignment.
4. Under rare circumstances, with the upper control arm cams adjusted all of the way in, the upper control arm will be extremely close to the coilover at full droop. Options to increase clearance include rotating the coil on the coilover assembly so that the arm comes between the windings of the coil or decrease the caster to the low end of specifications (shifts the upper ball joint forward).
5. Check all hardware after 500 miles.
6. Grease the ball joint at regular service intervals. Replacement ball joint # is 500-1104
7. Adjust headlights.



## **WE WANT TO SEE YOUR RIDE!**

Grab photos of your BDS-equipped truck in action and send them in for a chance to be featured. Send it in to our Bad Ass Rides customer gallery at [bds-suspension.com/bar](http://bds-suspension.com/bar) and post them on the BDS Fan Page on Facebook at [facebook.com/BDSSuspensions](https://facebook.com/BDSSuspensions). Don't forget about your BDS swag! BDS offers t-shirts, hoodies, decals and more available on the BDS website or through your local BDS distributor.

---

## **TIME TO HAVE SOME FUN**

**Thank you for choosing BDS Suspension.**

For questions, technical support and warranty issues relating to this BDS Suspension product, please contact your distributor/installer before contacting BDS Suspension directly.