

# INSTALLATION GUIDE

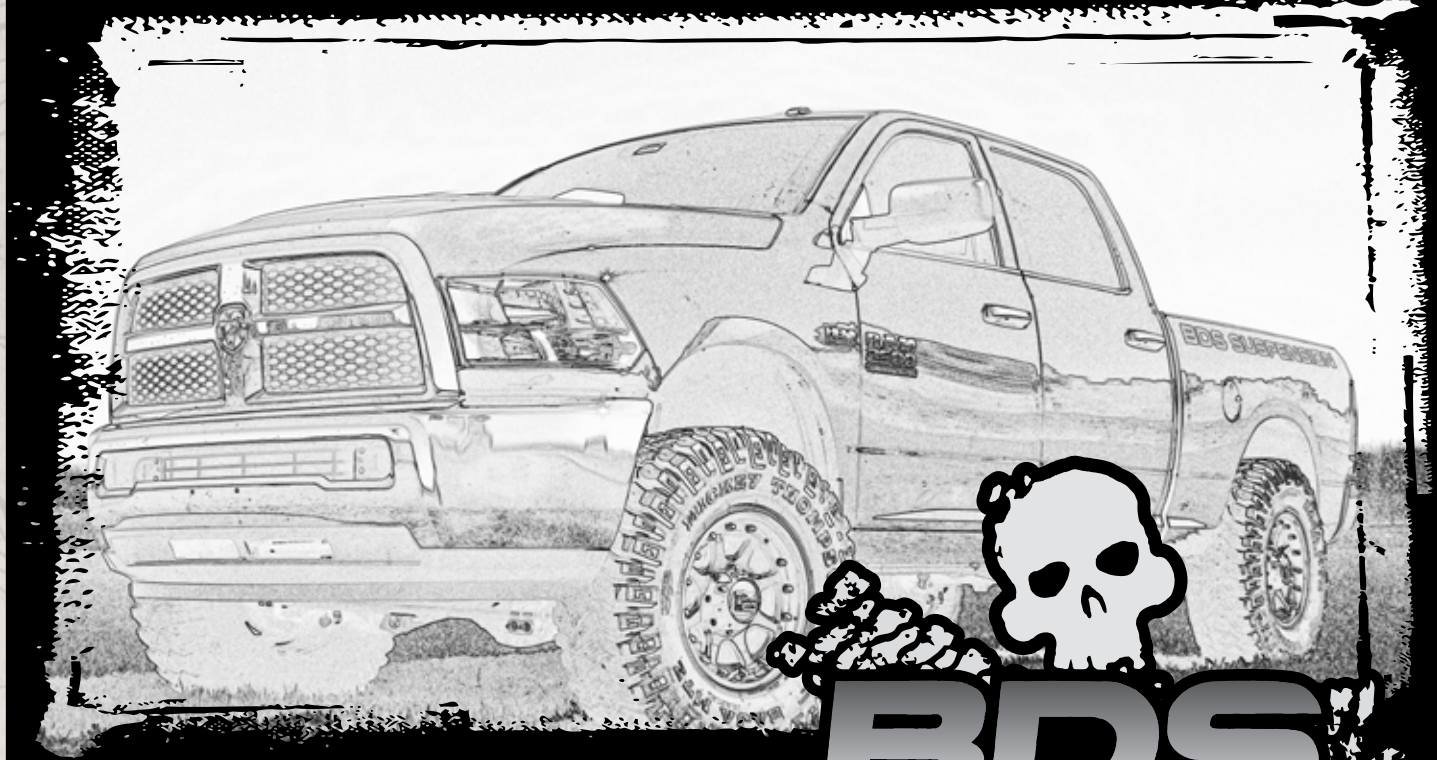

Part#: 012205

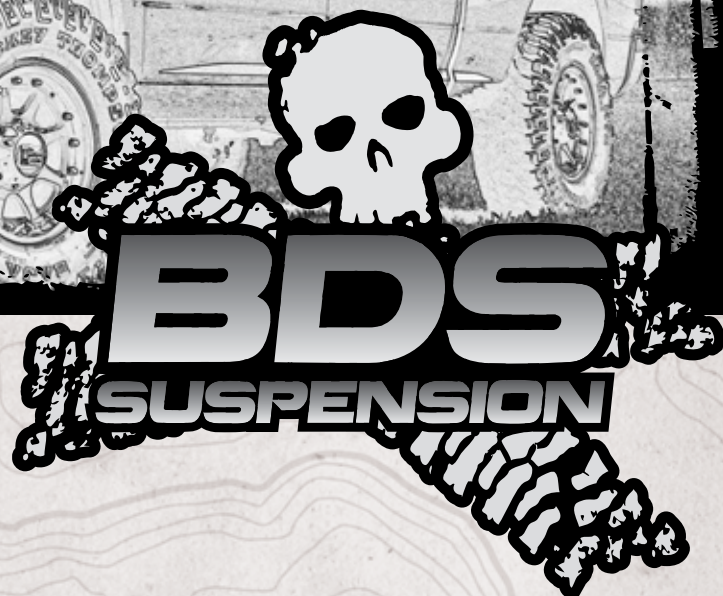

**HARDCORE LIMITED LIFETIME WARRANTY**

## 2" Suspension Lift

**Dodge 2500 4WD Pickup Air Ride | 2014-2016**

Rev. 091318

491 W. Garfield Ave., Coldwater, MI 49036 • Phone: 517-279-2135

E-mail: [tech-bds@ridefox.com](mailto:tech-bds@ridefox.com)

# Read And Understand All Instructions And Warnings Prior To Installation Of System And Operation Of Vehicle.

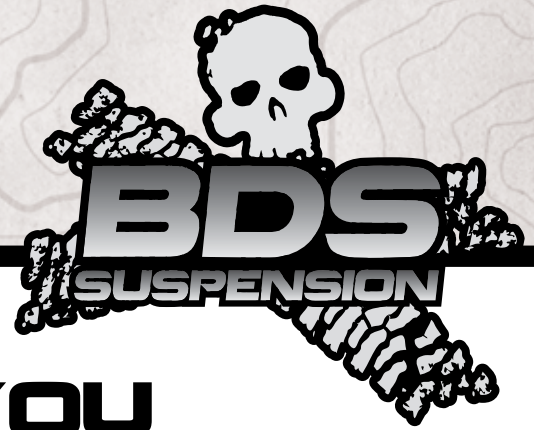

## THANK YOU

Your truck is about to be fitted with the best suspension system on the market today. That means you will be driving the baddest looking truck in the neighborhood, and you'll have the warranty to ensure that it stays that way for years to come. Thank you for choosing BDS Suspension!

### BEFORE YOU START

BDS Suspension Co. recommends this system be installed by a professional technician. In addition to these instructions, professional knowledge of disassembly/ reassembly procedures and post installation checks must be known.

### FOR YOUR SAFETY

Certain BDS Suspension products are intended to improve off-road performance. Modifying your vehicle for off-road use may result in the vehicle handling differently than a factory equipped vehicle. Extreme care must be used to prevent loss of control or vehicle rollover. Failure to drive your modified vehicle safely may result in serious injury or death. BDS Suspension Co. does not recommend the combined use of suspension lifts, body lifts, or other lifting devices. You should never operate your modified vehicle under the influence of alcohol or drugs. Always drive your modified vehicle at reduced speeds to ensure your ability to control your vehicle under all driving conditions. Always wear your seat belt.

### BEFORE INSTALLATION

- Special literature required: OE Service Manual for model/year of vehicle. Refer to manual for proper disassembly/reassembly procedures of OE and related components.
- Adhere to recommendations when replacement fasteners, retainers and keepers are called out in the OE manual.
- Larger rim and tire combinations may increase leverage on suspension, steering, and related components. When selecting combinations larger than OE, consider the additional stress you could be inducing on the OE and related components.
- Post suspension system vehicles may experience drive line vibrations. Angles may require tuning, slider on shaft may require replacement, shafts may need to be lengthened or trued, and U-joints may need to be replaced.
- Secure and properly block vehicle prior to installation of BDS Suspension components. Always wear safety glasses when using power tools.
- If installation is to be performed without a hoist, BDS Suspension Co. recommends rear alterations first.
- Due to payload options and initial ride height variances, the amount of lift is a base figure. Final ride height dimensions may vary in accordance to original vehicle attitude. Always measure the attitude prior to beginning installation.



Visit [560plus.com](http://560plus.com) for more information.

### TIRES AND WHEELS

Tire Size: 35 x 12.50"  
Wheel Size: 17x9  
Backspacing: 5"



### BEFORE YOU DRIVE

Check all fasteners for proper torque. Check to ensure for adequate clearance between all rotating, mobile, fixed, and heated members. Verify clearance between exhaust and brake lines, fuel lines, fuel tank, floor boards and wiring harness. Check steering gear for clearance. Test and inspect brake system.

Perform steering sweep to ensure front brake hoses have adequate slack and do not contact any rotating, mobile or heated members. Inspect rear brake hoses at full extension for adequate slack. Failure to perform hose check/ replacement may result in component failure. Longer replacement hoses, if needed can be purchased from a local parts supplier.

Perform head light check and adjustment.

Re-torque all fasteners after 500 miles. Always inspect fasteners and components during routine servicing.

# CONTENTS OF YOUR KIT

Parts List		
Part #	Qty	Description
02444	2	Dodge 2" Upper Strut Spacer
02378BK	2	Front Bump Stops
02975	2	Air Ride Sensor Bracket
462	1	Bolt Pack
	2	6mm Nylock Nut
	2	6mm x 20mm Bolt
	2	6mm flat washer
605	1	Bolt Pack
	2	7/16"-14 x 1 1/4" bolt grade 5
	2	7/16"-14 prevailing torque nut
	4	7/16" SAE washer

## TROUBLESHOOTING INFORMATION FOR YOUR VEHICLE

1. This system is designed for Ram 2500 vehicles with the factory radius arm front suspension and rear air ride suspension only.

**TECH  
TIPS**

# INSTALLATION INSTRUCTIONS

## FRONT INSTALLATION

1. Park vehicle on clean, flat, and level surface. Block the rear wheels for safety
2. Remove the front trackbar bolt from the frame. Do this while the vehicle is on the ground and there is a small amount of side load on the hardware.
3. Raise the front of the vehicle and support frame rails with jack stands.
4. Support the front axle with a hydraulic jack, and remove the front wheels.
5. Disconnect the 4 bolts that hold the sway bar to the frame, and allow the sway bar to swing down. (Fig 1)

**FIGURE 1**

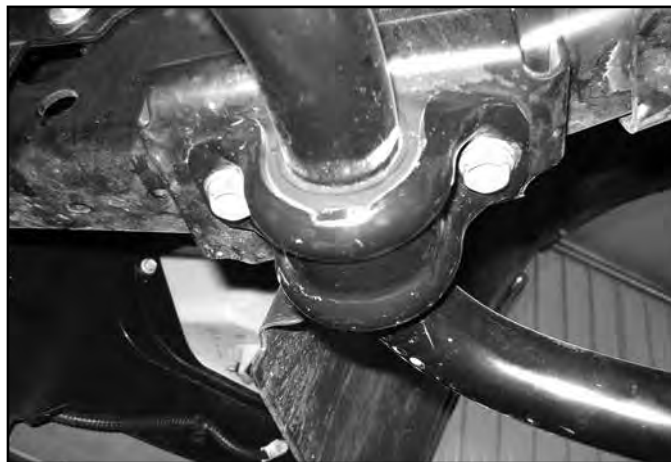

6. Disconnect the brake line brackets from the top of the radius arm mount on the front axle. (Fig 2)

**FIGURE 2**

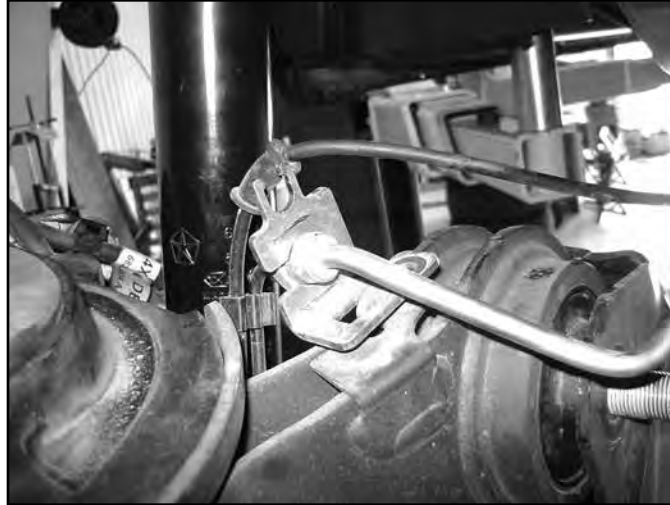

7. Disconnect the drag link from the pitman arm, use an appropriate puller, and do not damage the tie rod end boot.
8. Remove the front shocks, retain the lower mounting hardware. (Fig 3)

**FIGURE 3**



9. Lower the front axle and remove the coil springs. Check for appropriate slack in ABS wires, brake lines, and differential breather hose. Keep the coils separated, do not mix sides.
10. Remove the factory bump stops. It is easiest to remove them by hitting with a hammer on the side.

11. Install new spacers (02444) with 7/16" hardware (Bolt Pack #605) through the factory hole. Tighten to 35 ft-lbs. The orientation of the parts will be so that the weld seam is facing out away from the center of the vehicle. (Fig 4a - DRV, 4b - PASS)

**FIGURE 4A - DRV**



**FIGURE 4B - PASS**



12. Reinstall the factory upper isolator and coil springs. The tab on the isolator will go directly below the 7/16" bolt. Coil orientation is critical to keep the factory coils from bowing an excessive amount.
13. Raise front axle and install new shocks. Tighten upper bushings until they begin to swell. Tighten lower shock bolt to 70 ft-lbs. New front shocks last (3) digits will be 342 on the shock body. Fox shocks will have part # stamped in the cap 8340.
14. Reattach sway bar to the frame with factory hardware. Tighten to 40 ft-lbs.
15. Reattach the drag link to the pitman arm with factory hardware. Tighten to 65 ft-lbs.
16. Reattach the factory brake line brackets to the axle with factory hardware. Tighten to 12 ft-lbs.
17. Install wheels, if installing aftermarket wheels remove the retaining clips on the lug studs before installing new wheels. Tighten to factory specifications.
18. Grease new bump stops (02378BK) and place a block of wood under them. The weight of the vehicle will be used to press them into position.
19. Lower vehicle to the ground, and ensure that the bump stops are fully seated. (Fig 5)

**FIGURE 5**



20. Have an assistant turn the steering wheel and reattach the track bar to the frame with factory hardware. Tighten to 180 ft-lbs.

## REAR INSTALLATION

21. Pop the ride height sensor linkage from the ball stud. Remove the ball stud from the axle (Fig 6).

**FIGURE 6**

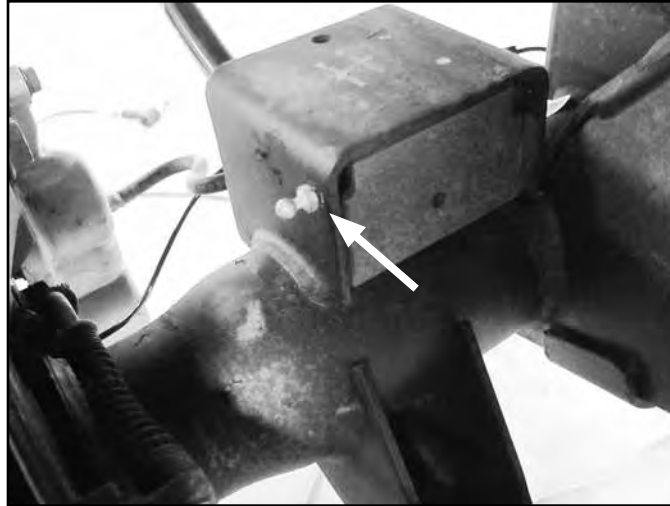

22. Fasten the sensor relocation brackets to the axle with the provided 6mm bolts and washers through the original ball stud hole (BP 462)

**FIGURE 7**

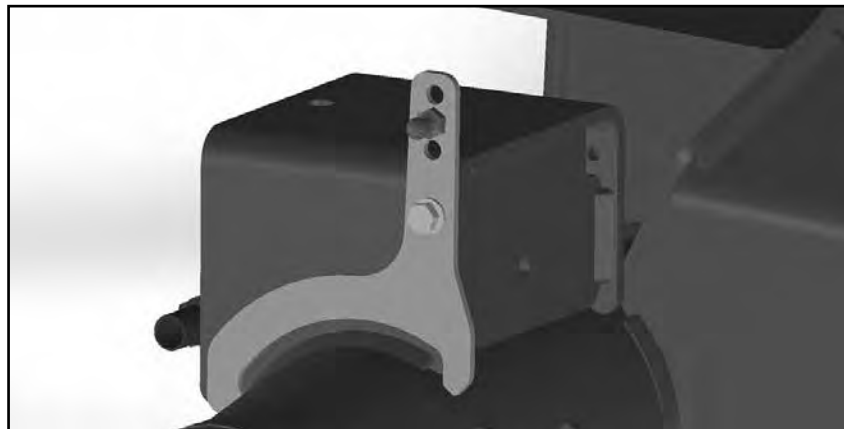

23. Transfer the ball stud on to the linkage bracket. Fasten with the provided 6mm nut (BP 462). The center position is recommended, but other holes will give approximately a 1/2" change in ride height in either direction if desired.
24. Snap the factory linkage factory linkage back on the stud.
25. **Rear Shock Installation:** Grease and install bushings and sleeves into new shocks. Install new shocks with new stem bushings and washers, the same as the factory shock setup. **Fox shocks only:** Fox shocks will require an offset stem eliminator bracket and bolt pack 946. The eye of the shock will need to be offset to the REAR of the vehicle to give the shock body clearance to the frame rail hole. Locate the OE frame hole towards the rear of the vehicle from the original stem mounting hole. Enlarge this hole using a 3/8" drill bit to fit to the tab on the offset bracket. Verify shock clearance to the frame opening, in may be necessary to slightly enlarge the opening due to variances in trucks, however this is highly unlikely. (Fig. 8)

**FIGURE 8**



## **FINAL INSTALLATION STEPS**

26. Perform a steering sweep and check for adequate clearance. Recheck all hardware for proper torque.
27. Adjust steering wheel to center by adjusting the collar on the drag link, do not drive the vehicle with the steering wheel crooked or traction control problems may arise.
28. Have an alignment performed. Recheck all hardware after 500 miles.



## **WE WANT TO SEE YOUR RIDE!**

Grab photos of your BDS-equipped truck in action and send them in for a chance to be featured. Send it in to our Bad Ass Rides customer gallery at [bds-suspension.com/bar](http://bds-suspension.com/bar) and post them on the BDS Fan Page on Facebook at [facebook.com/BDSSuspensions](https://facebook.com/BDSSuspensions). Don't forget about your BDS swag! BDS offers t-shirts, hoodies, decals and more available on the BDS website or through your local BDS distributor.

---

## **TIME TO HAVE SOME FUN**

**Thank you for choosing BDS Suspension.**

For questions, technical support and warranty issues relating to this BDS Suspension product, please contact your distributor/installer before contacting BDS Suspension directly.