

INSTALLATION GUIDE

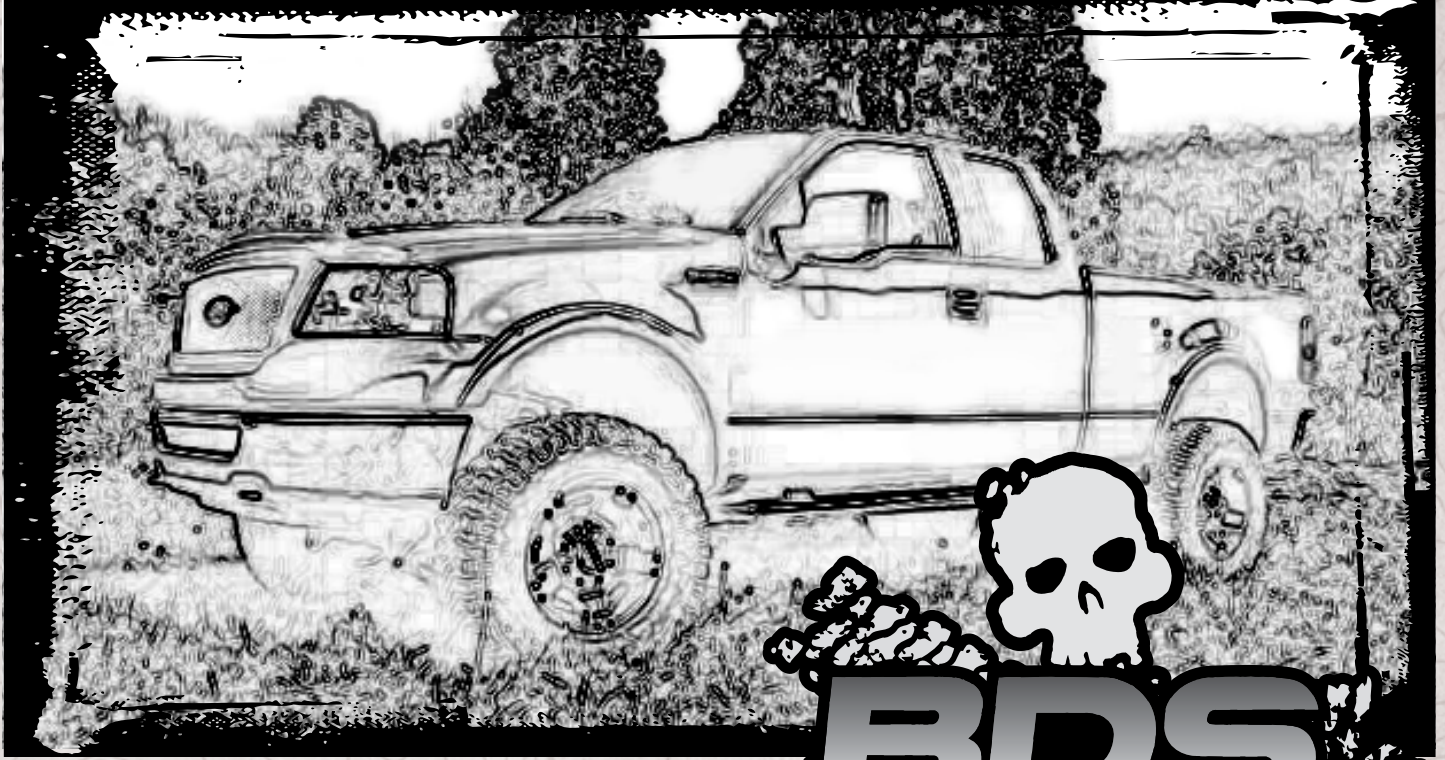

Part#: 023432, 023632



HARDCORE LIMITED LIFETIME WARRANTY

4-6" High Clearance System

Ford F-150 4WD | 2004-2008

Rev. 071416

491 W. Garfield Ave., Coldwater, MI 49036 • Phone: 517-279-2135

Web/live chat: www.bds-suspension.com • E-mail: tech-bds@sporttruckusainc.com

Read And Understand All Instructions And Warnings Prior To Installation Of System And Operation Of Vehicle.

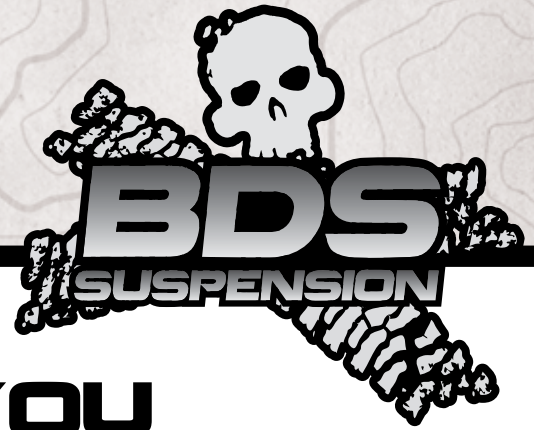

THANK YOU

Your truck is about to be fitted with the best suspension system on the market today. That means you will be driving the baddest looking truck in the neighborhood, and you'll have the warranty to ensure that it stays that way for years to come.

Thank you for choosing BDS Suspension!

BEFORE YOU START

BDS Suspension Co. recommends this system be installed by a professional technician. In addition to these instructions, professional knowledge of disassembly/ reassembly procedures and post installation checks must be known.

FOR YOUR SAFETY

Certain BDS Suspension products are intended to improve off-road performance. Modifying your vehicle for off-road use may result in the vehicle handling differently than a factory equipped vehicle. Extreme care must be used to prevent loss of control or vehicle rollover. Failure to drive your modified vehicle safely may result in serious injury or death. BDS Suspension Co. does not recommend the combined use of suspension lifts, body lifts, or other lifting devices. You should never operate your modified vehicle under the influence of alcohol or drugs. Always drive your modified vehicle at reduced speeds to ensure your ability to control your vehicle under all driving conditions. Always wear your seat belt.

BEFORE INSTALLATION

- Special literature required: OE Service Manual for model/year of vehicle. Refer to manual for proper disassembly/reassembly procedures of OE and related components.
- Adhere to recommendations when replacement fasteners, retainers and keepers are called out in the OE manual.
- Larger rim and tire combinations may increase leverage on suspension, steering, and related components. When selecting combinations larger than OE, consider the additional stress you could be inducing on the OE and related components.
- Post suspension system vehicles may experience drive line vibrations. Angles may require tuning, slider on shaft may require replacement, shafts may need to be lengthened or trued, and U-joints may need to be replaced.
- Secure and properly block vehicle prior to installation of BDS Suspension components. Always wear safety glasses when using power tools.
- If installation is to be performed without a hoist, BDS Suspension Co. recommends rear alterations first.
- Due to payload options and initial ride height variances, the amount of lift is a base figure. Final ride height dimensions may vary in accordance to original vehicle attitude. Always measure the attitude prior to beginning installation.



Visit 560plus.com for more information.

TIRES AND WHEELS

35 x 12.50 w/ 17x9 and 4-5/8" backspacing

Stock 17" rims cannot be reinstalled after the lift is completed. 17" wheels require 4-1/2" of backspacing.

Stock 18" & 20" wheels with stock tires can be reinstalled after the lift. Larger tires cannot be put on the factory 18-20" wheels. 20" wheels with 4-1/2" to 5-1/2" backspacing can be used.



BEFORE YOU DRIVE

Check all fasteners for proper torque. Check to ensure for adequate clearance between all rotating, mobile, fixed, and heated members. Verify clearance between exhaust and brake lines, fuel lines, fuel tank, floor boards and wiring harness. Check steering gear for clearance. Test and inspect brake system.

Perform steering sweep to ensure front brake hoses have adequate slack and do not contact any rotating, mobile or heated members. Inspect rear brake hoses at full extension for adequate slack. Failure to perform hose check/ replacement may result in component failure. Longer replacement hoses, if needed can be purchased from a local parts supplier.

Perform head light check and adjustment.

Re-torque all fasteners after 500 miles. Always inspect fasteners and components during routine servicing.

CONTENTS OF YOUR KIT

023630 Box Kit

Part #	Qty	Description
2064	1	Knuckle Driver's Side

023631 Box Kit

Part #	Qty	Description
2066	1	Knuckle Passenger's Side

023432/023632 Box Kits

Part #	Qty	Description
02070B	2	Sway Bar Drop
02402B	2	6" Strut Spacer (023632 only)
02401B	2	4.5" Strut Spacer (023432 only)
02093B	1	Rear Crossmember
02095B	1	Diff Skid Plate
02403B	1	Diff Skid Plate-PS
400408-15	1	15in x 5/16 Fuel Vent Hose
2002	4	Eccentric Cam Bolt
02002ZP	2	M18-2.5 x 150 Class 10.9 Bolt
2001	8	04 Ford F150 Eccentric Cam
W34USS	6	3/4 USS Flat Washer
N18MPT	6	M18 x 2.5 Prevailing Torq Nut
1602	1	Strap w/Stud
22524	1	Front Brake Line - DS
22525	1	Front Brake Line - PS
CCW-03-050	4	3/8 Brake Line Crush Washer
5188	2	Snap In Brake Line Clip
99000	6	11.5in Nylon Cable Tie
342701	1	Loctite - 1ml (11094-00764)

013508 Box Kit

Part #	Qty	Description
3396	2	3in x 3in Body Block
2032	2	Leaf Spring Plate
963141000QB	4	9/16 x 3-1/4 x 10 Square U-Bolt
N96FH-B	8	9/16 Fine High Nut
W96S-B	8	9/16 SAE Flat Washer
523	1	Bolt Pack
	2	10mm-1.50 x 110mm class 8.8
	2	10mm flat washer thru hardened
	2	18mm-2.50 x 140mm bolt class 10.9
	2	18mm-2.50 prevailing torque nut
	4	18mm flat washer

013209 Box Kit

Part #	Qty	Description
2FB-D	2	Ford F150 2in Rear Dual Pin Block
963181212QB	4	9/16 x 3-1/8 x 12-1/2 Square U-bolt
W96S-B	8	9/16 SAE Flat Washer
N96FH-B	8	9/16 Fine High Nut

023633 Box Kit

Part #	Qty	Description
2096	1	Backing Plate
2006	1	E-Brake Relocation Bracket
02092B	1	Front Crossmember
02406B	1	Diff Supt Brkt- PS
02094B	1	Diff Drop Bracket
02405B	1	Diff Drop Brkt- PS
2000	1	Differential Nut Tab
629	1	Bolt Pack - upper strut spacer
	6	10mm-1.50 prevailing torque nut
	6	3/8" USS flat washer
775	1	Bolt pack
	2	Wire Clip
	4	7/16" x 1-1/2" bolts
	8	7/16" SAE washer
	4	7/16"-14 prevailing torque nut
	1	3/8"-16 x 1-1/4" bolt (grade 5)
	2	3/8" SAE Washer
	1	3/8" Prevailing torque nut
	1	1/4"-20 nylock nut
	3	1/4" USS flat washer
	2	6mm-1.00 x 18mm bolt
776	1	Bolt pack
	1	7/16"-14 x 3-3/4" shcs bolt
	1	12mm-1.75 x 30mm bolt
	1	12mm-1.75 x 100mm bolt
	1	12mm-1.75 x 110mm bolt
	3	12mm-1.75 prevailing torque nut
	6	12mm flat washer
	6	1/2"-13 x 1-1/4" bolt
	6	1/2" SAE washer
	4	1/4"-20 x 1" stainless steel button head bolt
	4	1/4" USS Washer
	4	1/4"-20 nylock nut

013507 Box Kit

Part #	Qty	Description
2005	2	5in Flat Block w/Bump Stop
963181212QB	4	9/16 x 3-1/8 x 12-1/2 Square U-bolt
W96S-B	8	9/16 SAE Flat Washer
N96FH-B	8	9/16 Fine High Nut

TECH TIPS

TROUBLESHOOTING INFORMATION FOR YOUR VEHICLE

1. Supercrew models with 4ft bed do not require the add-a-leaf 113219.
2. All wheel drive models will require front driveshaft modification.
3. Although unusual, a 123609 rear driveshaft spacer may be required.
4. Will not fit HD models (7 lug).

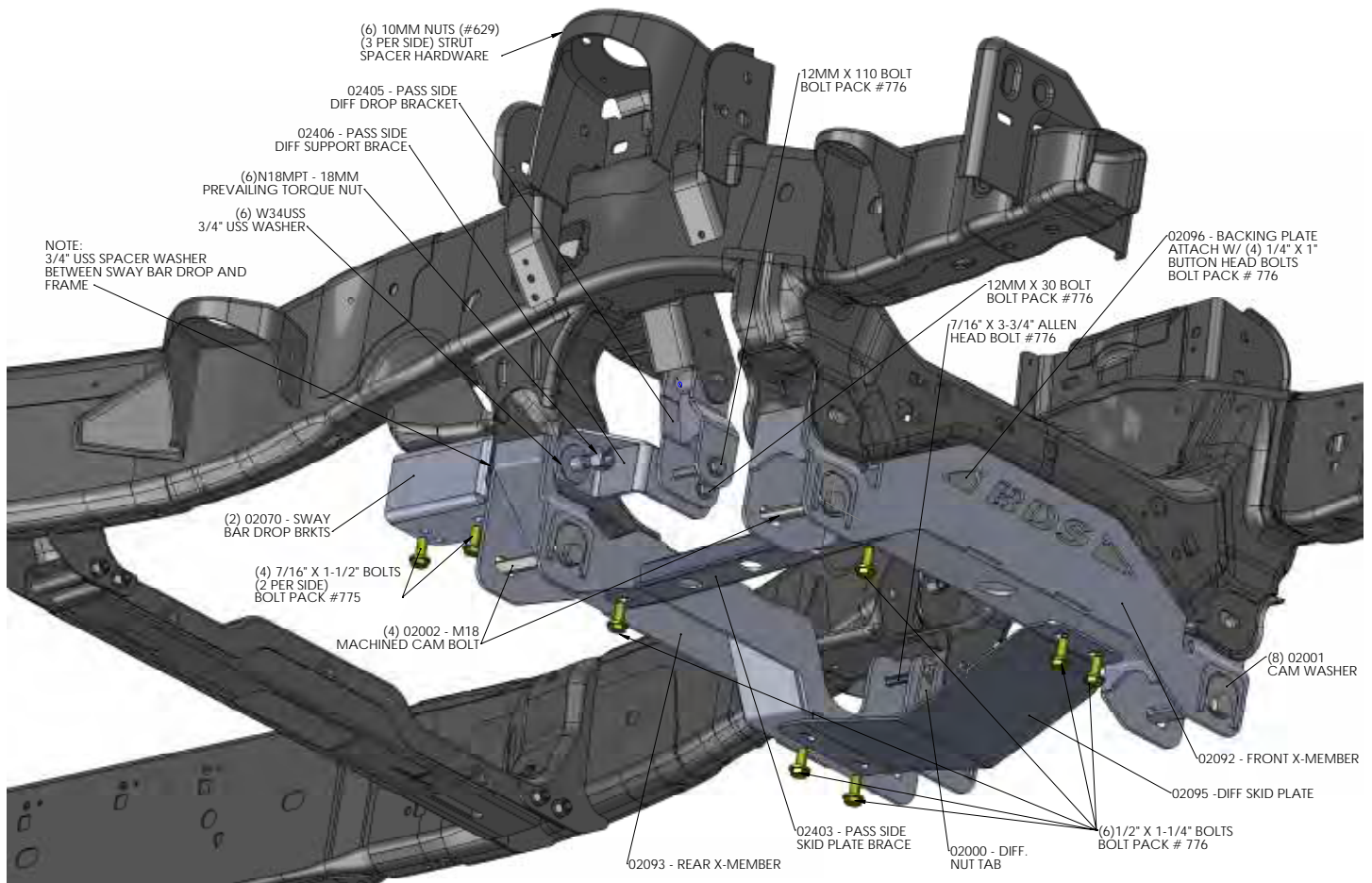

INSTALLATION INSTRUCTIONS

SPECIAL TOOLS

High Quality Strut compressor
4-1/2" Cutoff/Grinding disc
Reciprocating Saw

INSTALLATION INSTRUCTIONS

FRONT INSTALLATION

1. Park the vehicle on a clean, flat surface and block the rear wheels for safety.
2. Measure from the center of the wheel up to the bottom edge of the wheel opening and record below:
LF _____ RF _____
LR _____ RR _____
3. Raise the front of the vehicle and support with jack stands at each frame rail behind the lower control arms.
4. Remove the front wheels.
5. Remove the brake caliper anchor bracket bolts and remove the caliper from the knuckle (Fig 1). Hang the caliper out of the way. Do not let the caliper hang by the brake hoses.

FIGURE 1



6. Remove the brake rotor and set aside.
7. Disconnect the ABS and hub vacuum lines from the retaining clips (Fig 2).

FIGURE 2



8. Disconnect the hub vacuum line from the hub (Fig 3).

FIGURE 3



9. Disconnect the ABS line from the inner fender and disconnect ABS wire connector (Fig 4).

FIGURE 4



10. Disconnect the tie rod ends from the steering knuckles (Fig 5). Remove and retain the mounting nuts. Strike the steering knuckle near the tie rod end to dislodge the end. Take care not to strike the tie rod end.

FIGURE 5

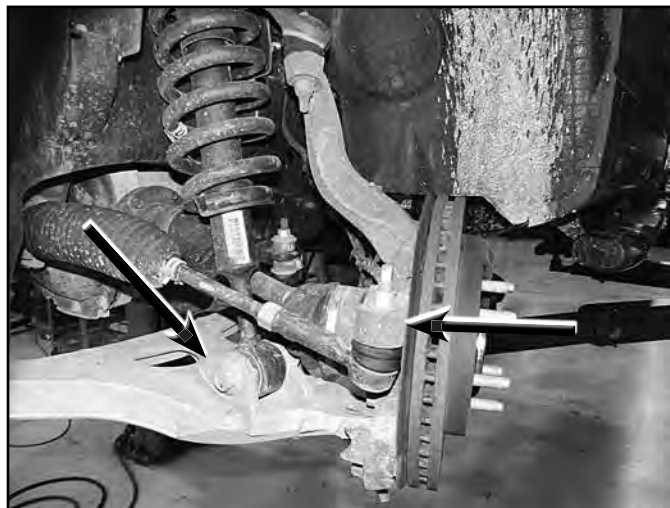

11. Disconnect the sway bar links from the sway bar (Fig 6). Retain hardware. The sway bar links do not need to be removed from the lower control arms. Note: Different models have different styles. The links will either have a stem or ball joint style mount at the sway bar (stem style shown).

FIGURE 6



12. Remove the four sway bar mounting nuts and remove the sway bar from the vehicle (Fig 7). Retain hardware.

FIGURE 7



- Carefully remove the hub dust cap to expose the axle shaft nut (Fig 8). Remove the nut. Retain the cap and nut, they will be reinstalled later.

FIGURE 8



- Remove the CV axle flange bolts (Fig 9). Retain bolts.

FIGURE 9



- Loosen but do not remove the three strut assembly mounting nuts at the frame (Fig 10). Do not loosen the middle strut nut.

FIGURE 10



- Loosen and remove the nut from the strut-to-lower control arm mounting bolt (Fig 5). Leave the bolt in place at this time. Retain the mounting nut.
- Remove the upper and lower ball joint nuts (Fig 5) and reinstall a few turns.
- Strike the knuckle near the upper and lower ball joints to dislodge the joints from the knuckle.
- Remove the upper ball joint and the strut-to-lower control arm bolt. Swing the knuckle/lower control arm down to remove the CV shaft from the hub. Set CV shaft aside. Retain ball joint nut and strut bolt.
- Remove the lower ball joint nut and remove the knuckle from the vehicle. Retain hardware.
- Remove the lower control arm mounting bolts and remove the lower control arm from the vehicle. Retain hardware.
- Mark the struts to distinguish between driver's and passenger's.
- Remove the three strut assembly mounting nuts at the frame and remove the strut assembly from the vehicle.
- Remove the four bolts mounting the OE rear crossmember to the frame rails (Fig 11) and remove the crossmember from the vehicle. Retain hardware and discard the crossmember.

FIGURE 11



25. Mark the relationship between the driveshaft and the input flange on the front differential. Remove the driveshaft mounting bolts and disconnect the driveshaft from the differential (Fig 12). Allow the driveshaft to rest out of the way. Retain hardware.

FIGURE 12



26. Support the front differential with an appropriate jack. Disconnect the differential breather hose from the differential housing. Remove the two driver's side and one passenger's side differential mounting bolts (Fig 12, 12a, 12b) and remove the differential from the vehicle. Note: To remove the driver's side front bolt, rotate the steering column to give the most clearance and slide the differential all of the way to the passenger's side to give enough room to get the bolt out. It may still be necessary on some trucks to loosen the steering rack to gain enough clearance.

FIGURE 12A



FIGURE 12B



27. Remove the differential breather hose from the connector up near the frame and replace it with the provided longer one.

28. The driver's side rear lower control arm frame pocket must be modified to provide clearance for the differential in its relocated position. On the front side measure from the inside edge of the control arm slot $\frac{3}{4}$ " and mark (Fig 13). Make a vertical cut line at the mark.

FIGURE 13

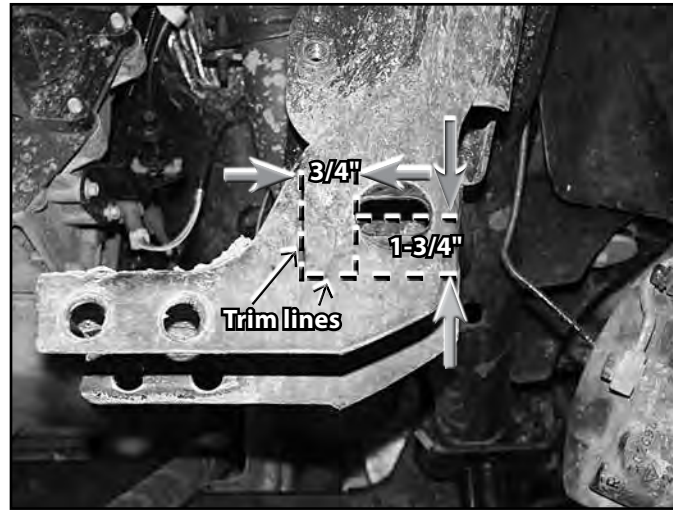

29. Measure down from the center of the slot 1-3/4" and make a horizontal cut line

30. On the back side measure from the inside edge of the control arm slot 1-3/4" and mark (Fig 14). Make a vertical cut line at the mark.

FIGURE 14

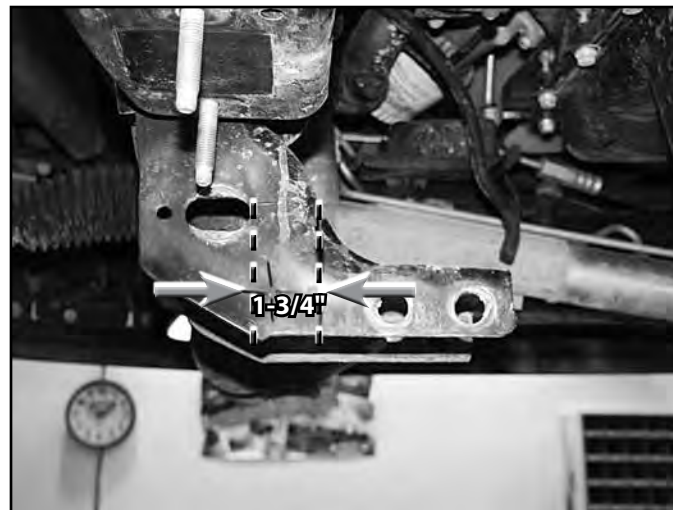

31. On the passengers side the front must be trimmed to clear the offset bend. Mark from the top of the factory crossmember hole over to the outside edge of the bracket. Trim up to the hole from the bottom. (Fig 15)

FIGURE 15



32. Install the rear crossmember with new 18mm bolts. With the crossmember installed, mark the hole for the driver's side rear differential hole. Remove crossmember and drill hole out to 1/2".

FIGURE 16C

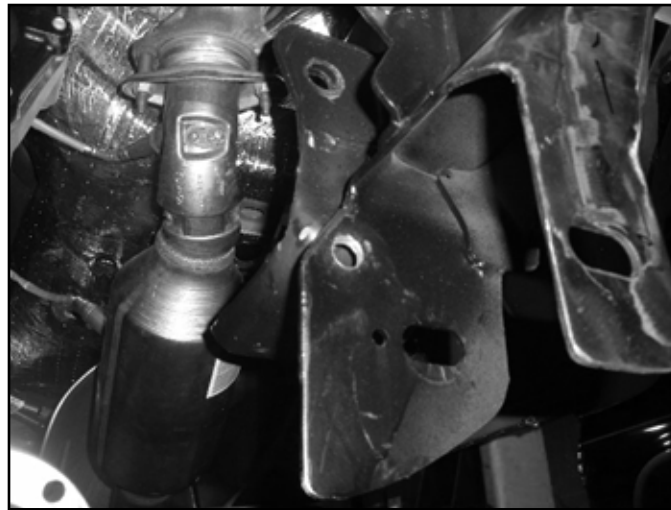

33. Install the provided sway bar drop brackets (02070) to the original sway bar mounting positions with the OE bolt tab from the top-down. Attach to the rear crossmember bolts with a 3/4" USS washer as a spacer between the bracket and frame pocket. The open side of the bracket will go to the inside of the vehicle. Place another 3/4" USS washer and 18mm nut on the new rear bolt. (Fig 6a/b)

FIGURE 16A



FIGURE 16B



34. Install the new rear crossmember (02093) in the rear lower control arm frame pockets and fasten with the OE control arm hardware. Run bolts from rear to front. Leave hardware loose, it will be removed for reinstalled later in the installation. Ensure the hole that was drilled in the frame pocket lines up to the differential mounting hole in the bracket.

35. Install the new passenger's side differential drop bracket (02405), this bracket has an extra hole on the lower wing (Fig 17a) and front driver's side (02094) (Fig 17b) OE differential mounting locations with the OE hardware. The brackets should offset toward the front of the vehicle when properly installed. Leave hardware loose.

FIGURE 17A

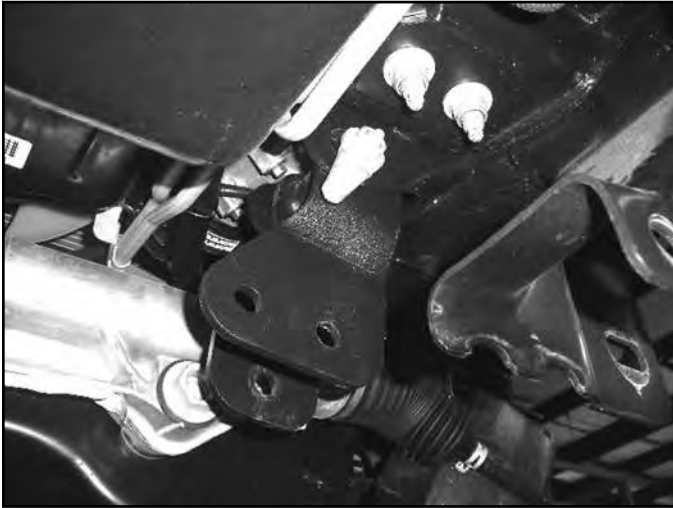
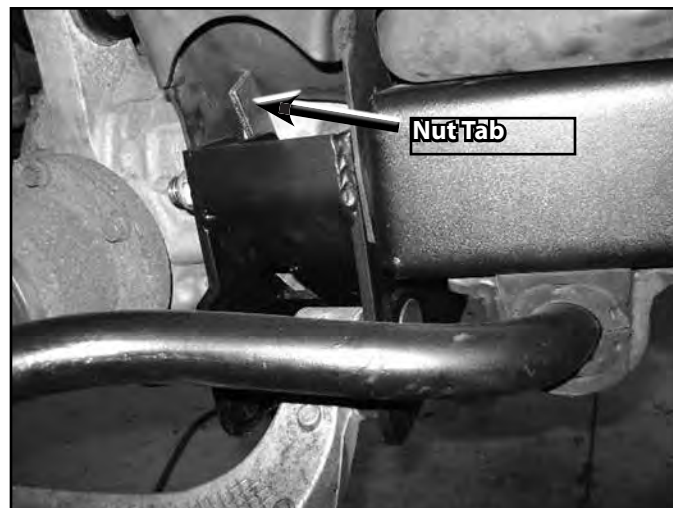

FIGURE 17B



36. Install the differential in the vehicle by aligning the differential mounts in the two front drop brackets and in the rear crossmember. Fasten the differential to the driver's front bracket with a 12mm x 100mm bolt, nut and 12mm washers (BP #776). Fasten to the passenger's side bracket with a 12mm x 110 bolt, nut and 12mm washers (BP #776), running from the front to rear. Leave all hardware loose.
37. Fasten the differential to the rear crossmember (Fig 18) with a 7/16" x 3-3/4" allen head bolt (BP #776) in conjunction with the provided nut tab (02000). Leave hardware loose.

FIGURE 18



38. Install the provided differential support bracket to the passenger's side differential bracket using the hardware that was just installed and an additional 12mm x 30mm bolt (BP #776). Attach the other end to the rear crossmember bolt. It is necessary to remove the bolt and reinstall it. Leave hardware loose. (Fig 19a/b)

FIGURE 19A



FIGURE 19B



39. Go back and torque all the differential mounting hardware to 50 ft-lbs (6 bolts total). Attach the differential breather hose to the differential.
40. Install the provided front crossmember backing plate (02096) on the front crossmember (02092) with 1/4" button head bolts, nuts and washers (BP #776). Torque bolts to 15 ft-lbs. This backing plate is zinc plated and can be repainted. This is an optional part in the kit and it is not necessary to install. The purpose is to add a background to the "BDS" cut-out in the crossmember.
41. Install the front crossmember in the front lower control arm pockets and fasten with the OE lower control arm hardware. Leave hardware loose. (Fig 20)

FIGURE 20



42. Install the lower control arms in the new crossmembers and fasten with the provided 18mm x 150mm cam bolts, cam washers and 18mm nuts. Run the bolts from rear to front. Center the cams in the slots.

43. Install the provided differential skid plate to the front and rear crossmembers with $\frac{1}{2}$ " x 1-1/4" bolts with Loc-tite and $\frac{1}{2}$ " SAE washers (BP #776) into the weld nuts in the crossmembers (Fig 21). Torque to 65 ft-lbs.

FIGURE 21

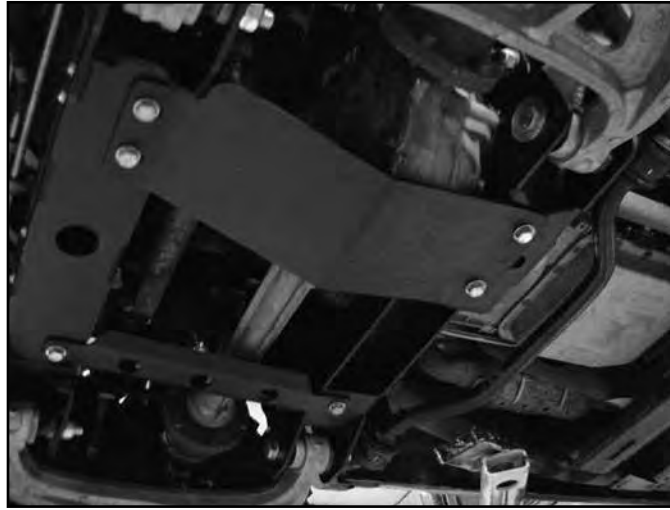

44. Install the passenger's side connecting plate with $\frac{1}{2}$ " x 1-1/4" bolts with Loc-tite and washers (BP #776).
45. Install the provided strut spacers on the struts with the OE hardware. Note: They will only install one way. Torque nuts to 35 ft-lbs.
46. Install the strut assemblies in the appropriate sides on the vehicle (Fig 22). The flat side will face 'out' on the vehicle. Fasten the spacers to the OE strut mounts with 10mm nuts and $\frac{3}{8}$ " USS washers (BP #629) on the welded studs. Leave hardware loose.

FIGURE 22



47. Remove the four hub bolts from the knuckle and remove the hub from the knuckle (Fig 23).

FIGURE 23

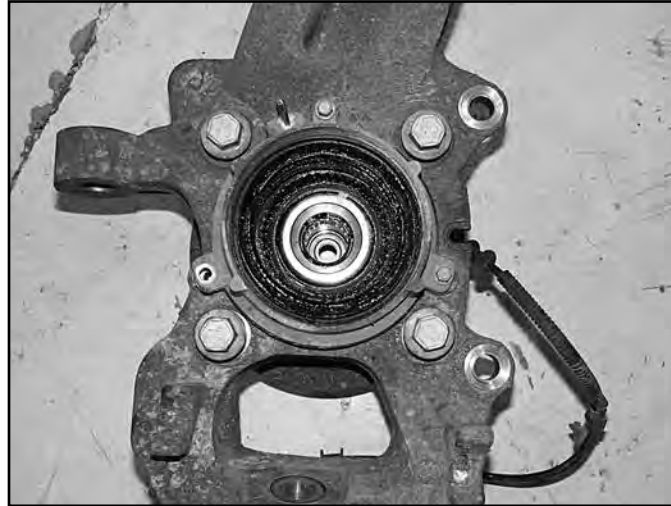

48. Inspect the outer hub assembly mounting surface and clean any dirt or corrosion off as necessary. Install the hub into the corresponding new BDS knuckle (drv- 02064, pass- 02065) and fasten with the OE bolts. Use Loctite on the bolt threads and torque to 148 ft-lbs. Install the ABS wire grommet in the slot in the knuckle.
49. Remove the three bolts mounting the vacuum hub assembly to the OE knuckle and reinstall the assembly in the corresponding new knuckle with the OE hardware. Tighten bolts securely (about 5-7 ft-lbs).
50. Remove the dust shield from the OE knuckle and install on the corresponding new knuckle with the original hardware (Fig 24). Tighten securely.

FIGURE 24

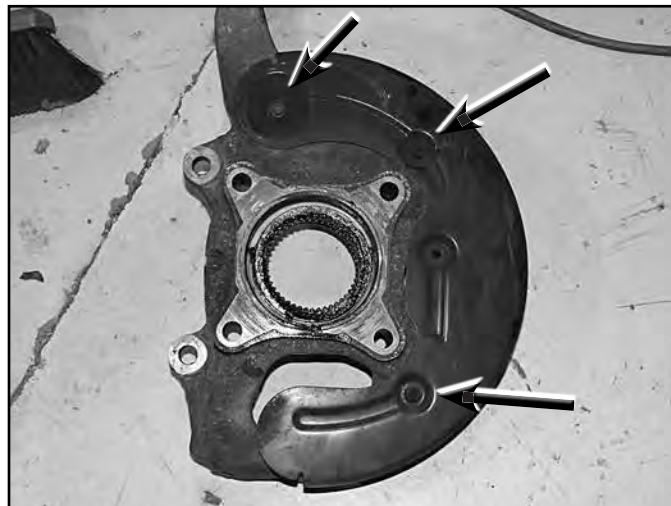

51. Install the new knuckle assembly on the lower control arm ball joint and loosely fasten with the original nut. Install the CV shaft in the hub, swing the whole assembly up and attach the lower control arm to the strut with the original hardware. Leave all hardware loose.
52. Attach the upper control arm to the knuckle with the original nut. Torque the upper ball joint to 85 ft-lbs and the lower ball joint to 111 ft-lbs.
53. Torque the upper strut nuts to 35 ft-lbs. The lower bolt will be tightened later with the weight of the vehicle on the suspension.
54. Fasten the CV shaft to the hub with the original nut and torque to 20 ft-lbs. Reinstall the dust cap.
55. Attach the CV shaft to the differential output flange with the original hardware. Torque bolts to 60 ft-lbs in a crossing pattern.
56. Install tie rod from top-down. Torque to 111 ft-lbs.
57. Disconnect the OE front brake line from the caliper and retain bolt, discard crush washers. Disconnect the brake line from the hard line at the frame and remove the brake line retain clip to free the brake line from the frame bracket. Retain clip and discard the brake line.

58. Install the new BDS brake line (22524/22525) to the caliper with the OE banjo bolt and two new crush washers (one on each side of the fitting). The brake lines are driver's and passenger's side specific. The end of the brake line should go up and around the bleeder on the caliper. Torque the banjo bolt to 20 ft-lbs. (Fig 25a / 24b)

FIGURE 25A

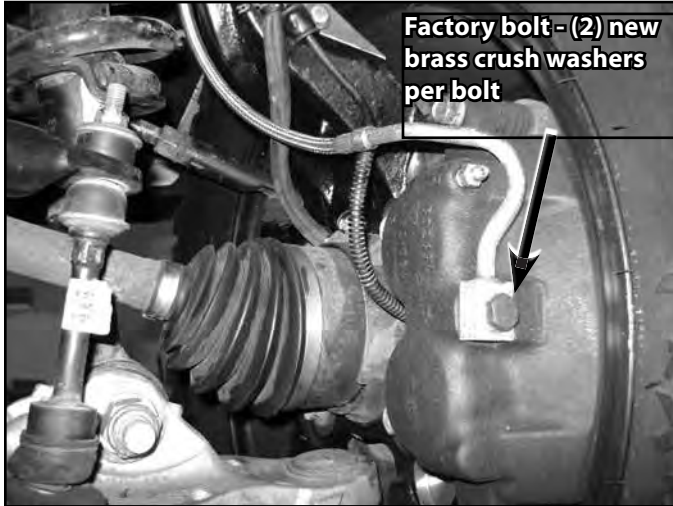
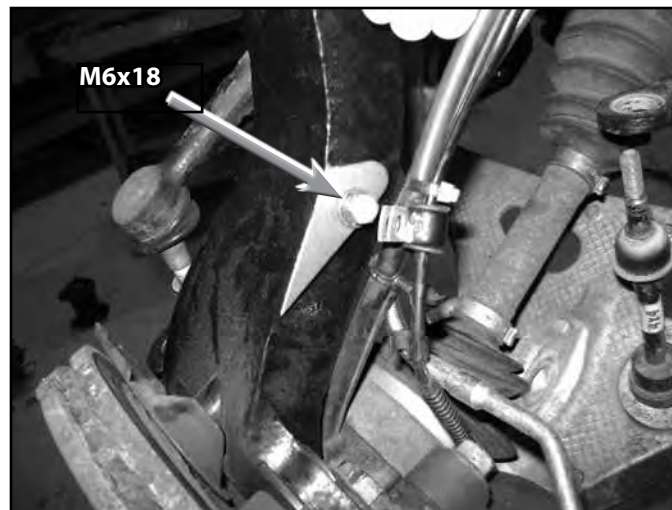

FIGURE 25B



59. Run the brake hard line through the brake line frame mount and attach the new brake line. Tighten fitting securely.
60. Install the new brake line in the frame bracket and fasten with the OE retaining clip.
61. Install the brake rotor and caliper to the knuckle. Fasten the caliper with the OE bolts and torque to 148 ft-lbs.
62. Attach the ABS line to the connector at the inner fender and the vacuum line to the hub. Route the lines (include the brake line) down the back of the knuckle and attach with zip ties at the upper control arm. Attach the ABS wire to the side of the knuckle with the provided wire clip, 6mm x 18mm bolt, and 1/4" washer (BP #775) (Fig 26).

FIGURE 26



63. Torque 10mm sway bar drop hardware to 35 ft-lbs and 18mm front and rear crossmember mount bolts to 222 ft-lbs. Ensure that the front crossmember is centered in the vehicle. Use a socket on an extension to easily access the nuts. (Fig 27)

FIGURE 27



64. Install the sway bar to the new sway bar drop brackets with 7/16" x 1-1/2" bolts, nuts and 7/16" SAE washers (BP #775). Attach the sway bar to the sway bar end links with the original hardware. Torque the 7/16" hardware to 45 ft-lbs. If the sway bar link is a stem style, tighten hardware until the bushings begin to swell. If the link is a ball joint style, torque nut to 45 ft-lbs.
65. Reattach front driveshaft to differential. Torque bolts to 76 ft-lbs.
66. Install the wheels and lower the vehicle to the ground.
67. Bounce the front of the vehicle to settle the suspension. Torque the lower strut mount bolt to 350 ft-lbs. Center the lower control arm cams and torque to 150 ft-lbs. tighten upper strut mounting hardware on replacement strut kits to 35 ft-lbs.
68. Bleed the brakes. Follow procedure outlined in the service manual.
69. Check all hardware for proper torque.

REAR INSTALLATION

70. Block the front wheels and raise the rear of the vehicle. Place jack stands under the frame rails ahead of the spring hangers.
71. Remove the wheels.
72. The parking brake cable must be relocated. To disconnect the cable from the frame first pull down on the cable and clamp it off with vise grips near the middle of the frame (Fig 28). This will gain slack to disconnect the driver's side rear cable from the main (passenger's side) cable.

FIGURE 28



73. Remove the driver's side parking brake cable from the junction bracket (Fig 29).

FIGURE 29



74. Compress the retaining tabs and remove the driver's side cable from the spring hanger (Fig 31). It will be relocated and reconnected later.
75. Support the rear axle with a hydraulic jack. Remove the OE shocks. Retain mounting hardware.
76. Disconnect the rear brake line from the frame.



Tip

Note: Perform the rear installation on one side at a time.

BLOCK AND ADD-A-LEAF KIT (SKIP ADD-A-LEAF STEPS IF NOT ORDERED)

77. Remove the passenger's side u-bolts.
78. Lower the axle and remove the OE lift block, it will not be reused with 6" front kits.
79. Using C-clamps, clamp the leaf spring pack together on each side of the center pins. Remove the center pins and discard. Retain the top u-bolt plate on the leaf spring pack.
80. Slowly release the leaf spring pack. Be sure not to mix up the order and orientation of the leaves.
81. Remove the rivets and then remove the two OE leaf alignment clamps. The rivet head can be removed with a grinder, reciprocating saw or air chisel.
82. Install the provided anti-friction pads on the top surface at each end of the provided add-a-leaf (113219).
83. Insert the add-a-leaf in the OE leaf pack where the leaf above it is longer and the leaf below is shorter. Align the center pin holes in the entire pack together (including the top u-bolt plate) with two new center pins. Draw the pack together with C-clamps and tighten the center pins to 50 ft-lbs. DO NOT pull the leaf pack together with the center pins.
84. Install the provided two-piece leaf alignment clamps at each end of the leaf pack.
85. Install the new provided lift block so that the bump stop wing goes toward the inside of the vehicle. 2" kits will require the aluminum block to be placed under the factory block.
86. Raise the axle/block to the spring while aligning the center pins. Fasten the spring/block assembly with the provided u-bolts, high nuts and washers. Snug u-bolts, they will be torque with the weight of the vehicle on the springs.



Repeat installation procedure on the driver's side of the vehicle. Remove the driver's side parking brake cable bracket from the front spring hanger. Remove the front bracket mounting bolt and the nut from the spring bolt and remove the bracket. Retain hardware.

LEAF SPRING

87. Remove the passenger's side u-bolts. Lower the axle away from the spring. Retain the OE lift block, it will be reused.



Tip

Note: In order to remove the front spring hanger bolts the fuel tank and exhaust must be lowered. This kit includes two new replacement 18mm spring hanger bolts. The addition of these bolts to the kit will allow the installer to cut the head of the OE front spring hanger bolt off and pull it out toward the outside of the vehicle. Using this method will eliminate the need to lower the exhaust or fuel tank.

88. Remove the shackle-to-frame and spring-to-frame leaf spring bolts and remove the spring from the vehicle.

89. Remove the OE shackle from the spring and transfer it to the corresponding end of the new spring (003509). Loosely attach the shackle with the OE bolt.

90. Install the new leaf spring in the vehicle so that the short end of the axle shim is to the front of the vehicle. Fasten the shackle to the frame with the OE bolt and the spring to the front hanger with the OE bolt unless it was cut, in which case use the provided 18mm x 140mm bolt, nut and 18mm washers (BP #523). Leave hardware loose. Note for driver's side: Run the passenger's side emergency brake cable over the top of the spring.

91. Install the OE lift block on the axle so that the bump stop wing is toward the inside of the vehicle.

92. Raise the axle/block to the spring while aligning the center pins. Install the provided spring plate (02032) over the center pins. Fasten the spring/block assembly with the provided u-bolts, high nuts and washers. Snug u-bolts, they will be torque with the weight of the vehicle on the springs.

93. Remove the OE bump stop from the frame and reinstall with the provided bump stop spacer (3396), 10mm x 110mm bolt and 10mm washer (BP #523). Torque bolt to 30 ft-lbs (Fig 30).

FIGURE 30



Repeat installation procedure on the driver's side of the vehicle. When removing the driver's side front spring hanger bolt also remove the parking brake cable bracket by removing the front mounting bolt. Retain hardware.

BOTH REAR LIFT OPTIONS

94. Install the provided parking brake relocation bracket to the driver's side front spring hanger using the spring bolt. The front tab of the bracket should wrap around the front of the hanger and line up with an existing hole. Fasten the bracket with the OE parking brake bracket bolt and the spring hanger bolt. Torque the smaller bolt to 25 ft-lbs.



Tip

Note: If no hole is present, drill center of one slot to 3/8" and attach with 3/8" x 1-1/4" bolt, washers, and nut. (Fig 31)

FIGURE 31



95. Run the parking brake cable through the relocation bracket and reattach to the parking brake cable junction. When reconnected, remove the clamp to allow the cable to return to its normal tension.
96. Install the provided brake line relocation bracket to the driver's side frame rail with the OE brake line bracket bolt (Fig 31). Torque to 15 ft-lbs.

FIGURE 32

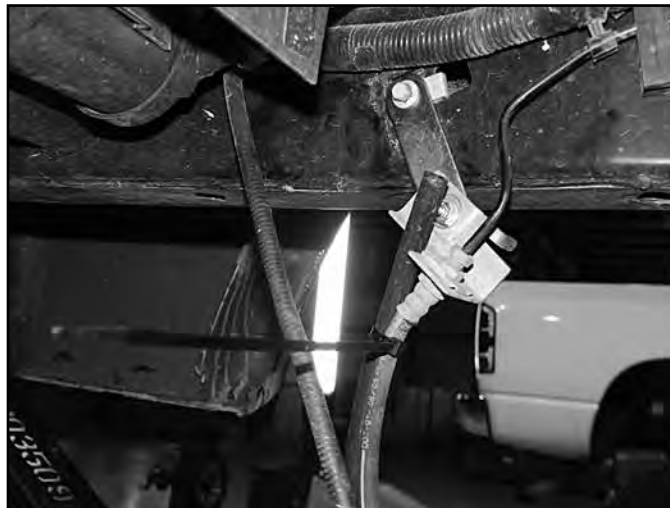

97. Attach the brake line to the relocation bracket with a 1/4" nut and 1/4" USS washer (BP #522). Torque to 15 ft-lbs.
98. Install the provided new BDS shocks with the OE hardware. Torque to 60 ft-lbs.
99. Check all lines/wires for proper slack.
100. Install the wheels and lower the vehicle to the ground.
101. Bounce the rear of the vehicle to settle the suspension.
102. Torque the front spring hanger bolts to 222 ft-lbs. Torque the shackle bolts to 98 ft-lbs.
103. Torque the u-bolts to 100-120 ft-lbs.
104. Check all hardware for proper torque

- 105. Check hardware after 500 miles.
- 106. A complete front end alignment is necessary.
- 107. Adjust headlights.



Tip

Although unusually rare, if front driveline vibration occurs the front driveshaft must be indexed as shown in the attached figure. The missing spline on the driveshaft must be cut / machined. Use extra caution to not damage the adjacent splines. Thoroughly clean and grease the splines before the driveshaft is reassembled. Reinstall the OE rubber boot with the OE clamp. The driveshaft must be rebalanced before the vehicle is driven.

FIGURE 33

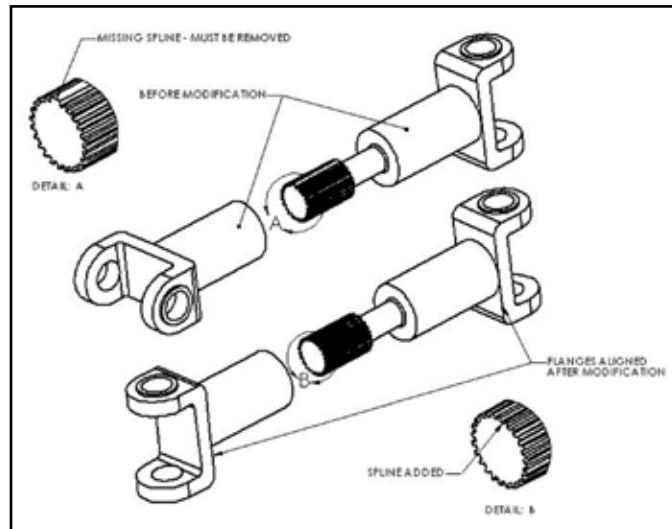

WE WANT TO SEE YOUR RIDE!

Grab photos of your BDS-equipped truck in action and send them in for a chance to be featured. Send it in to our Bad Ass Rides customer gallery at bds-suspension.com/bar and post them on the BDS Fan Page on Facebook at facebook.com/BDSsuspensions. Don't forget about your BDS swag! BDS offers t-shirts, hoodies, decals and more available on the BDS website or through your local BDS distributor.

TIME TO HAVE SOME FUN

Thank you for choosing BDS Suspension.

For questions, technical support and warranty issues relating to this BDS Suspension product, please contact your distributor/installer before contacting BDS Suspension directly.