

INSTALLATION GUIDE



Part#: 021302

HARDCORE LIMITED LIFETIME WARRANTY

3" Coilover Suspension System

Chevy/GMC 2500/3500 HD Pickup 2WD/4WD | 2020-24

Rev. 121724

491 W. Garfield Ave., Coldwater, MI 49036 • Phone: 517-279-2135
E-mail: tech-bds@ridefox.com

Read And Understand All Instructions And Warnings Prior To Installation Of System And Operation Of Vehicle.



THANK YOU

Your truck is about to be fitted with the best suspension system on the market today. That means you will be driving the baddest looking truck in the neighborhood, and you'll have the warranty to ensure that it stays that way for years to come. Thank you for choosing BDS Suspension!

BEFORE YOU START

BDS Suspension Co. recommends this system be installed by a professional technician. In addition to these instructions, professional knowledge of disassembly/ reassembly procedures and post installation checks must be known.

FOR YOUR SAFETY

Certain BDS Suspension products are intended to improve off-road performance. Modifying your vehicle for off-road use may result in the vehicle handling differently than a factory equipped vehicle. Extreme care must be used to prevent loss of control or vehicle rollover. Failure to drive your modified vehicle safely may result in serious injury or death. BDS Suspension Co. does not recommend the combined use of suspension lifts, body lifts, or other lifting devices. You should never operate your modified vehicle under the influence of alcohol or drugs. Always drive your modified vehicle at reduced speeds to ensure your ability to control your vehicle under all driving conditions. Always wear your seat belt.

BEFORE INSTALLATION

- Special literature required: OE Service Manual for model/year of vehicle. Refer to manual for proper disassembly/reassembly procedures of OE and related components.
- Adhere to recommendations when replacement fasteners, retainers and keepers are called out in the OE manual.
- Larger rim and tire combinations may increase leverage on suspension, steering, and related components. When selecting combinations larger than OE, consider the additional stress you could be inducing on the OE and related components.
- Post suspension system vehicles may experience drive line vibrations. Angles may require tuning, slider on shaft may require replacement, shafts may need to be lengthened or trued, and U-joints may need to be replaced.
- Secure and properly block vehicle prior to installation of BDS Suspension components. Always wear safety glasses when using power tools.
- If installation is to be performed without a hoist, BDS Suspension Co. recommends rear alterations first.
- Due to payload options and initial ride height variances, the amount of lift is a base figure. Final ride height dimensions may vary in accordance to original vehicle attitude. Always measure the attitude prior to beginning installation.



Visit 560plus.com for more information.

TIRES AND WHEELS

3" Kit:

- 35 x 12.50 on 17" x 9" w/ 4-1/2 to 5-1/2" Backspacing**
- 285/75 on 17x9" w/ 4-1/2 to 5-1/2" Backspacing*
- 35 x 12.50 on 18" x 9" w/ 4-1/2 to 5-1/2" Backspacing**
- 285/70 on 18x9" w/ 4-1/2 to 5-1/2" Backspacing*
- 35 x 12.50 on 20" x 9" w/ 4-1/2 to 5-1/2" Backspacing**
- 295/60 on 20" x 9" w/ 4-1/2 to 5-1/2" Backspacing*
- Larger than 20", use 20" wheel specs

**Trimming is required.

*Trimming may be required.

Stock 17", 18", and 20" wheels will not fit back on the vehicle once this suspension system is installed."

BEFORE YOU DRIVE

Check all fasteners for proper torque. Check to ensure for adequate clearance between all rotating, mobile, fixed, and heated members. Verify clearance between exhaust and brake lines, fuel lines, fuel tank, floor boards and wiring harness. Check steering gear for clearance. Test and inspect brake system.

Perform steering sweep to ensure front brake hoses have adequate slack and do not contact any rotating, mobile or heated members. Inspect rear brake hoses at full extension for adequate slack. Failure to perform hose check/ replacement may result in component failure. Longer replacement hoses, if needed can be purchased from a local parts supplier.

Perform head light check and adjustment.

Re-torque all fasteners after 500 miles. Always inspect fasteners and components during routine servicing.

CONTENTS OF YOUR KIT

021302 - Coilover Conversion Box Kit

Part #	Qty	Description
73	2	Differential Drop Spacer 7/8" Tall
75	2	Differential Drop Spacer 1/2" Tall
679	1	Differential Drop Bolt Pack
03906	1	Coilover Weld in Gusset Plate - Driver
03907	1	Coilover Weld in Gusset Plate - Passenger
03911	2	Coilover Clearance Weld-in Plate
03871	1	Tie Rod Wrench
K750322	2	Sway Bar End Link
03904	1	Coilover Mount - Driver
03905	1	Coilover Mount - Passenger
03908	2	CV Axle Spacer
401-2043	2	Heavy Duty Tie Rod Assembly
03909	1	Reservoir Mount - Driver
03910	1	Reservoir Mount - Passenger
05359	4	Bump Stop Spacer - 1/4"
890	1	Bolt Pack - CV Spacer
891	1	Bolt Pack - Coilover Conversion Hardware
BP1041	1	Bolt Pack - Bump Stop Spacer

021303 - LCA Box Kit - DRV

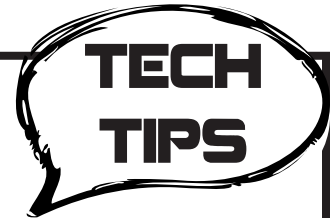
Part #	Qty	Description
A374	1	LCA Assembly - DRV
03915	1	Coilover Conversion LCA - DRV
K500232	1	Lower Ball Joint
MB08B700720	1	Rear Lower Bushing
MB08B700710	1	Front Lower Bushing
02802	1	BDS Large Logo
97525A430	2	18-8 SS Blind Rivet

121301 - UCA Box Kit

Part #	Qty	Description
A372	1	UCA Assembly - DRV
03913	1	Coilover Conversion UCA - DRV
500-1105	1	Ball Joint
02839	2	Bushing - UCA
02911	1	Aluminum Cap - Anodized
9452K145	1	O-ring (#139)
A373	1	UCA Assembly - PASS
03914	1	Coilover Conversion UCA - PASS
500-1105	1	Ball Joint
02839	2	Bushing - UCA
02911	1	Aluminum Cap - Anodized
9452K145	1	O-ring (#139)

021304 - LCA Box Kit - DRV

Part #	Qty	Description
A375	1	LCA Assembly - DRV
03916	1	Coilover Conversion LCA - DRV
K500232	1	Lower Ball Joint
MB08B700720	1	Rear Lower Bushing
MB08B700710	1	Front Lower Bushing
02802	1	BDS Large Logo
97525A430	2	18-8 SS Blind Rivet



IMPORTANT INFORMATION FOR YOUR VEHICLE

- Models with two-piece rear drive shafts will require a carrier bearing drop kit. (BDS121612)
- Requires frame bracket modification.
- Disassembly/assembly of the factory torsion bar system requires the use of a special unloading tool. The GM specified tool # is CH48809.
- Compatible with diesel models ONLY. Works with standard or AT4 diesel models.
- Some minor trim will be required with certain wheel/tire combination. This is normal with most aftermarket tire/wheel fitment on Chevy/GM trucks. Trimming will normally include the bottom edge of the inner fender shrouds and/or lower corner of front bumper valance. As a rule of thumb, deeper backspacing and shorter/narrower tires will reduce/eliminate trimming required. Further trimming tips are included at the end of this instruction sheet.
- Factory 17", 18" and 20" wheels cannot be reinstalled due to upper control arm clearance.
- Coilover coil has a large amount of preload, a coil spring compressor must be used to remove the coil from the coilover. Failure to use a coil spring compressor may result in death or injury.
- Do NOT increase coilover preload.
- For replacement ball joints use service kit BDS081203. Ball joints are directional and must be installed with the 'dot' facing either inward or outward on the vehicle, otherwise damage may occur.
- Increase of 1" of track width per side (2" overall) is done to create a better travel range of the suspension to allow more droop travel from ride height along width helping the coilover clear the frame components.

PRE INSTALLATION

IMPORTANT

It is required that ride height measurements be taken before and after installation. Measure from the **WHEEL AXLE CENTER** up to the **FENDER LIP** of the wheel opening. Do this for all 4 wheels. Record measurements below.**

BEFORE

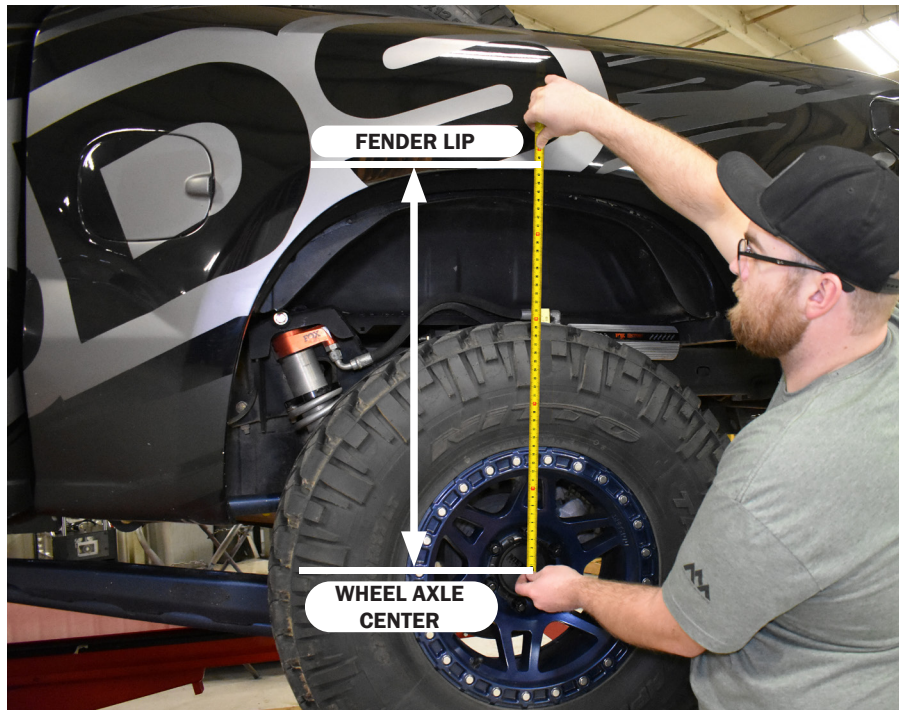
Left Front _____ *Right Front* _____

Left Rear _____ *Right Rear* _____

AFTER

Left Front _____ *Right Front* _____

Left Rear _____ *Right Rear* _____



****These ride heights will be required if you have any ride height concerns after installation. Please be prepared to provide these to Technical Support.**

INSTALLATION INSTRUCTIONS

FRONT DISASSEMBLY

1. Park the vehicle on a flat, clean surface and block the rear wheels for safety.
2. Raise the front of the vehicle and support with jack stands under the frame rails.
3. Remove the wheels.
4. Measure and record the length of the exposed thread on the torsion bar adjuster bolts (Fig. 1). Record the lengths here for use later during the installation

SPECIAL TOOLS

1-1/2" (38mm) socket/wrench
36mm socket
T30 Torx bit
1-1/16" (27mm) socket/wrench
Torsion Bar Unloading tool (see Pre-Installation Note #2)
Reciprocating Saw
4" Cut-off Wheel/Tool
3/16" Rivet Gun

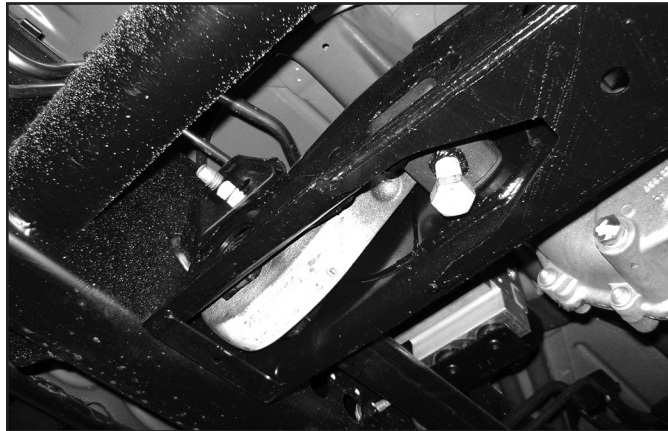
DRV Side: _____ PASS Side: _____

5. Unload the torsion bars but do not remove. Remove and discard the adjuster bolt/retainer block. (Fig.1)



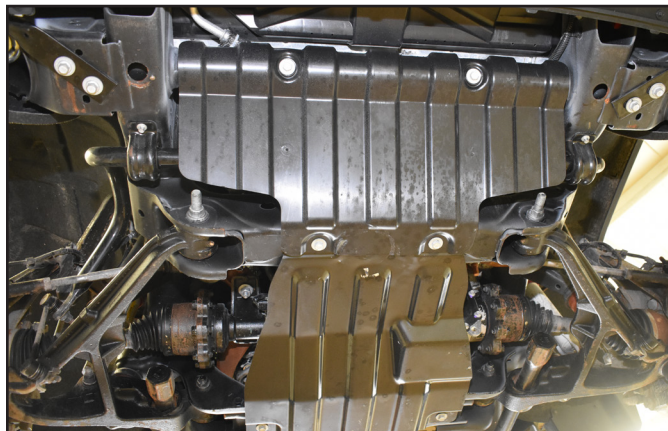
Tip Torsion bars are under extreme pressure. A proper torsion bar tool is necessary to unload the bars. A tool designed specifically for GM torsion bars is required see troubleshooting note #2.

FIGURE 1



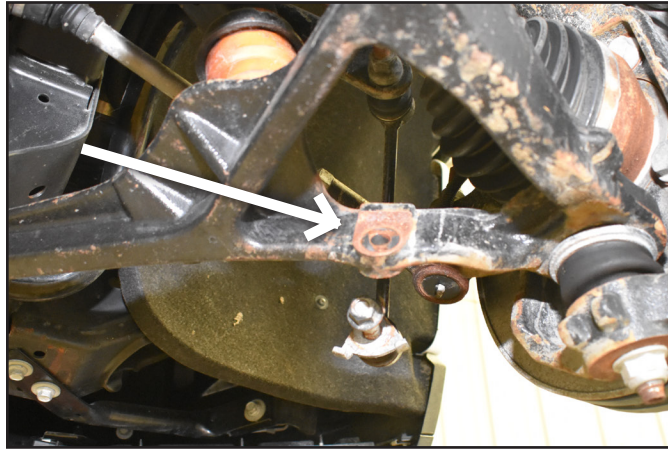
6. Mark the unloaded torsion bars to indicate DRV side and PASS side. Also mark the bars to indicate front versus rear.
7. Remove the torsion bar adjuster key by pushing the torsion bar forward to allow the key to drop free. On some vehicles this will require using a hammer/punch or air hammer. Access the end of the torsion bar through the hole in the back of the torsion bar cross member and drive forward. Leave the torsion bars in the lower control arms.
8. The torsion bar cross member can either be removed, allowing the torsion bars to be removed out the back of the vehicle. Or the torsion bar and lower control arms can be removed together later in the installation, leaving the torsion bar cross member in place.
9. If equipped, remove the four bolts mounting the factory belly pan to the frame and the two bolts mounting the front skid to the cross member (Fig. 2). These will not be reused.

FIGURE 2



10. Disconnect the sway bar end links from the sway bar and then the lower control arms (Fig. 3). Discard the link assemblies.

FIGURE 3



11. Disconnect the tie rod ends from the steering knuckles (Fig. 4). Remove the tie rod end nuts and save. Strike the knuckle near the tie rod end to dislodge the tie rod end taper. Remove the tie rod ends from the knuckles.

FIGURE 4



12. Remove the plastic retainers holding the ABS / brake wire to the brackets frame (Fig. 5) and the knuckle (Fig. 6a Fig. 6b) (Driver Side Shown). Leave the brackets attached to the frame and knuckle. Disconnect the ABS Sensor from the steering knuckle (Fig. 7).

FIGURE 5

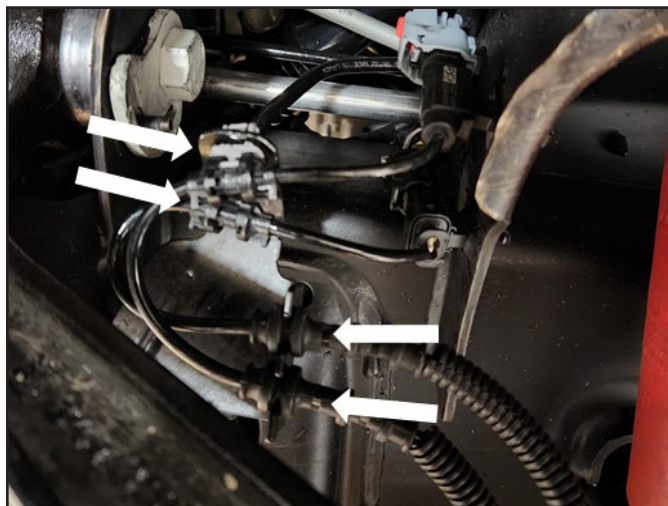


FIGURE 6A

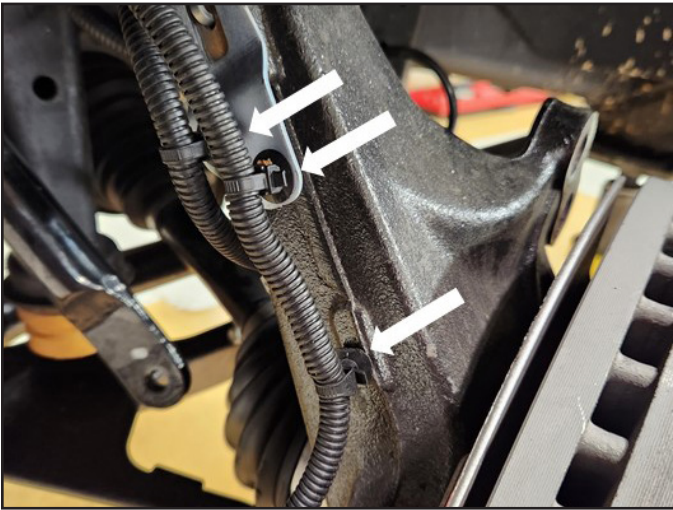


FIGURE 6B

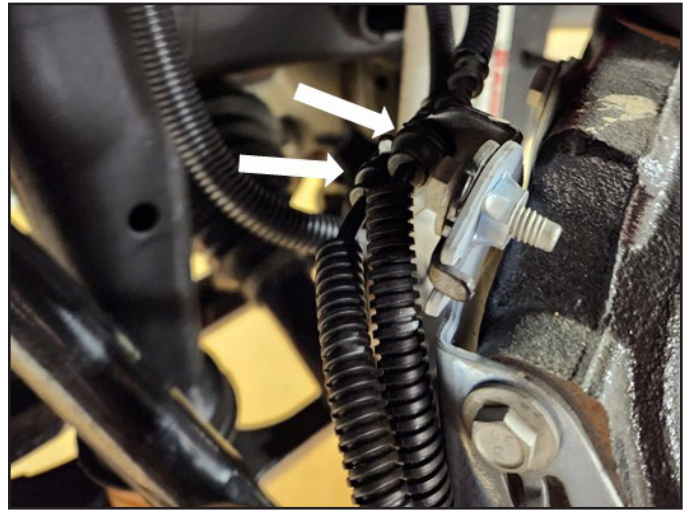
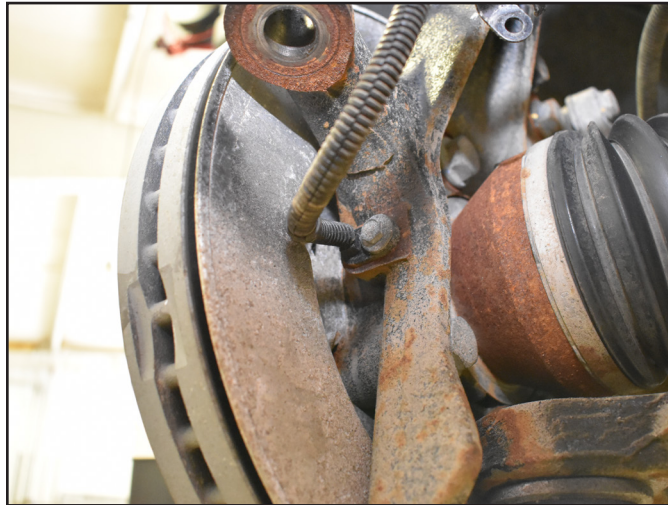


FIGURE 7



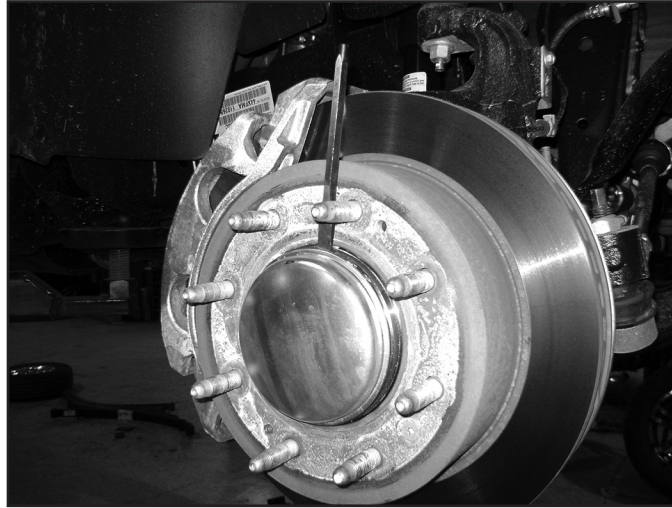
13. Remove the four bolts mounting the brake caliper assembly to the steering knuckle and hang the caliper out of the way (**Fig. 8**). Do not hang the caliper by the brake hose. Save mounting bolts.

FIGURE 8



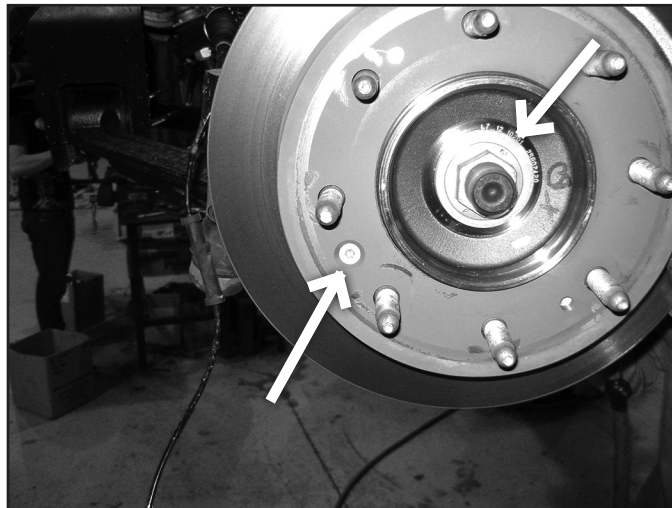
14. Carefully remove the hub dust cover. Save cover (Fig. 9).

FIGURE 9



15. Remove the rotor retaining bolt using a T30 torx bit (Fig. 10). Remove the brake rotor and set aside. Save retaining bolt.
16. Remove the CV axle nut and washer (Fig. 10). Save hardware.

FIGURE 10



17. Remove the upper ball joint nut, reinstall a couple of turns. Hit the side of the knuckle to dislodge the upper ball joint from the steering knuckle. Remove the factory upper control arm from the vehicle. (Figure 11A, 11B)

FIGURE 11A

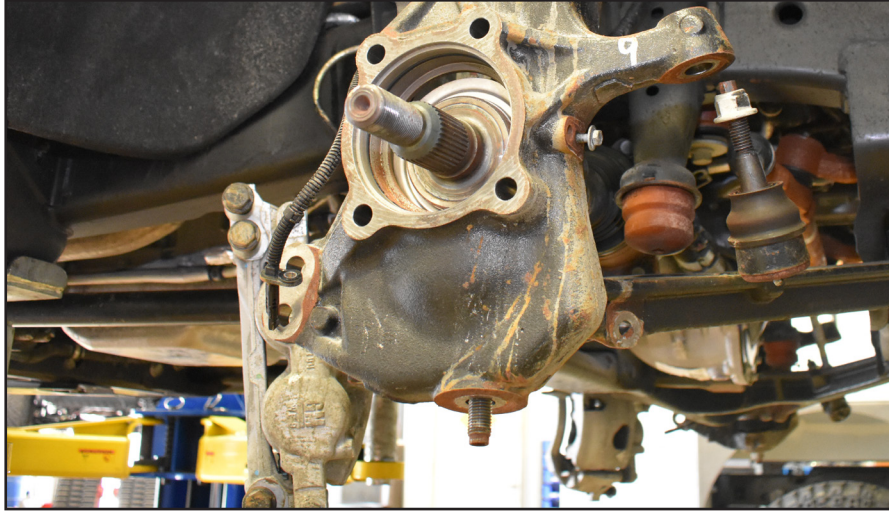


FIGURE 11B



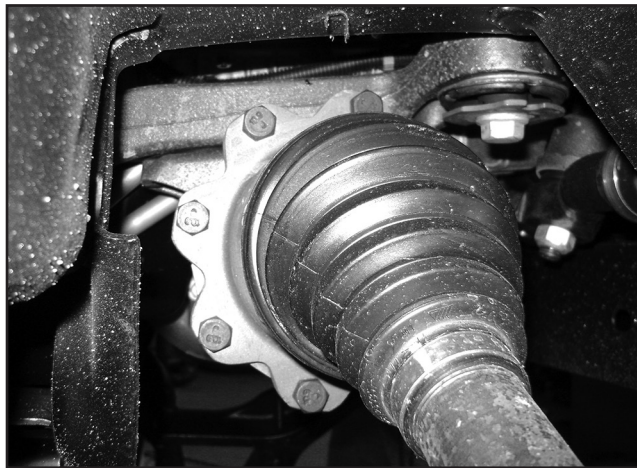
18. Remove lower ball joint nut (Fig. 12). Reinstall the nuts a couple of turns by hand. Taking care not to strike the ball joint Strike the knuckle near the ball joints to release the taper. Remove the nut and remove the steering knuckle from the vehicle. Save nuts and the o-rings.

FIGURE 12



19. Remove the CV axle flange bolts at the differential (Fig. 13). There are 8 bolts per side. Remove the CV shafts from the vehicle and set aside. Discard bolts.

FIGURE 13



20. Disconnect the shocks from the frame (Fig. 14A) and lower control arm (Fig. 14B). Remove shocks. Save the upper and lower shock mount hardware.

FIGURE 14A

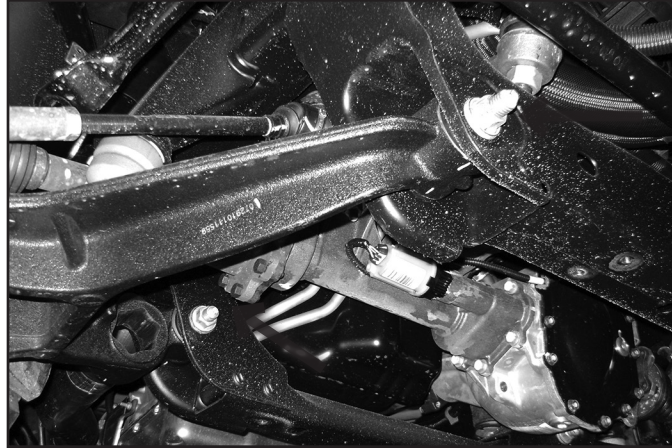


FIGURE 14B



21. Remove the front and rear lower control arm bolts and remove the control arms from the vehicle (Fig. 15). Save the mounting hardware and discard the control arms.

FIGURE 15



DIFFERENTIAL DROP INSTALLATION

22. Work on one side of the vehicle at a time. Support differential (Fig. 16).

FIGURE 16



23. Reach up and over to access mount 21 mm nut, diff mount bolt. (Fig. 17)

FIGURE 17



24. Lower the differential and install the spacers between the frame mounting points and the factory brackets. Use the short 1/2" tall spacer at the rear mount with (Sockets - 22mm Bolt, 21 mm nut) 9/16" x 5" hardware from Bolt Pack 679. Use the tall 7/8" spacer at the front mount with 9/16" x 5-1/2" hardware. (Figure 18A & B). Torque the 9/16" hardware to 118 ft-lbs. DO NOT TIGHTEN UNTIL HARDWARE IS MOUNTED ON BOTH SIDES. TIP: Leave hardware loose to assist in the spacer install on the other side of the vehicle.

FIGURE 18A

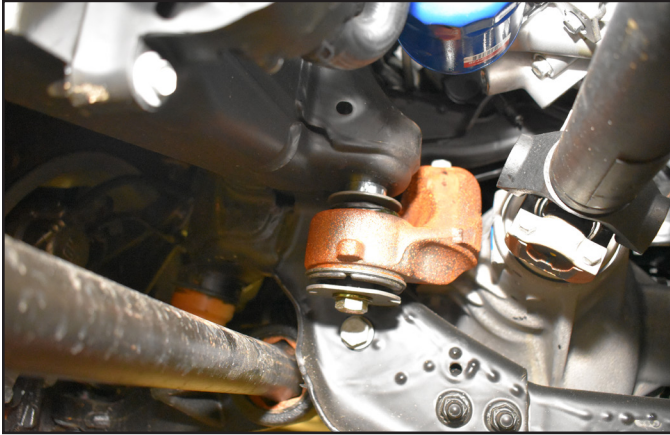
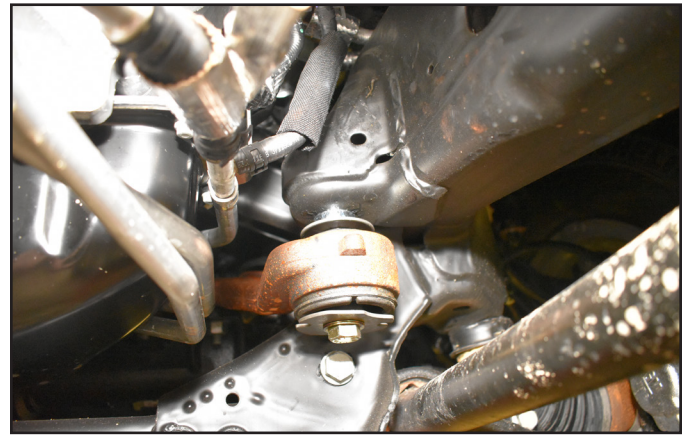


FIGURE 18B



CONTROL ARM AND COILOVER INSTALLATION

25. Disconnect ABS/Brake line clips and brackets from strut bucket and frame. (Fig. 19A, 19B)

FIGURE 19A



FIGURE 19B



26. Prep the area by the upper shock mount for welding. Remove the GM undercoating in this area. ADD Images 32,33,34 Using brake clean with a putty knife is the easiest way to remove large chunks of the undercoating.

FIGURE 20A

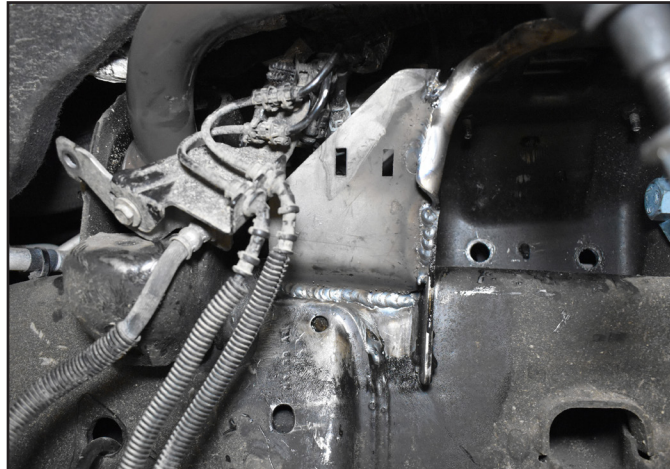


FIGURE 20B

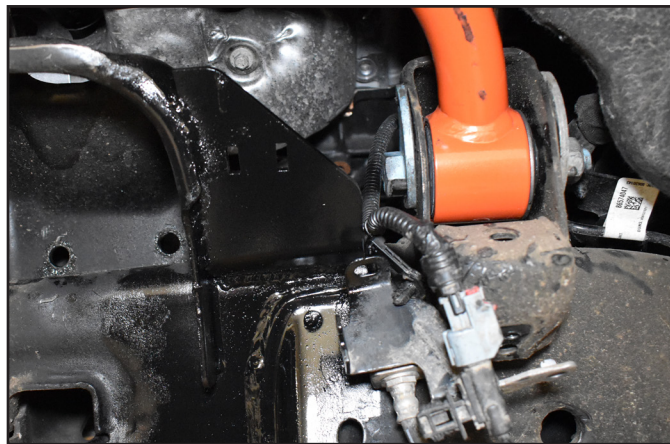


27. Place the weld-in support plate against the factory brackets. Ensure area is properly prepared for welding. Weld plate with appropriate mig or tig welder, certified welder highly recommended. (Fig 21)

FIGURE 21



28. Allow plate to cool, coat bare metal with paint. (Fig. 22) The weld in plate can be used to attach the OE ABS and brake sensor wires to it using the factory oval christmas tree mounts.



29. Place the upper coilover bracket against the factory shock mounting bracket using the 1/2" x 1-1/2" bolt and 1/2" hardware in bolt pack 891 to position the bracket. Mark center of the lower two holes and drill out to 1/2". (Fig 23A, 23B)


 **Tip** Clearance is very tight on the back side of the driver side. Be careful not to drill through any lines on the back side of the OE frame mount.

FIGURE 23A

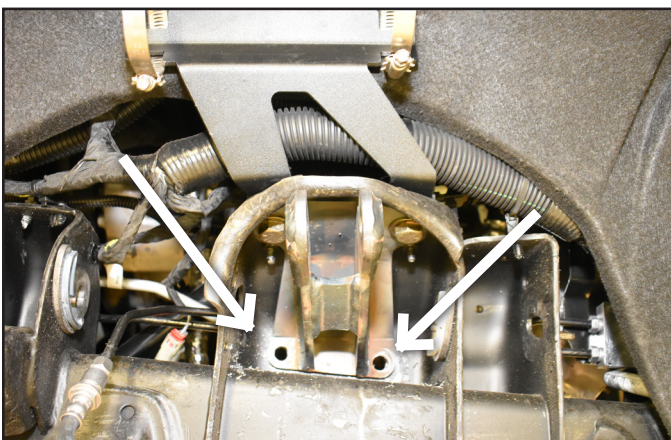
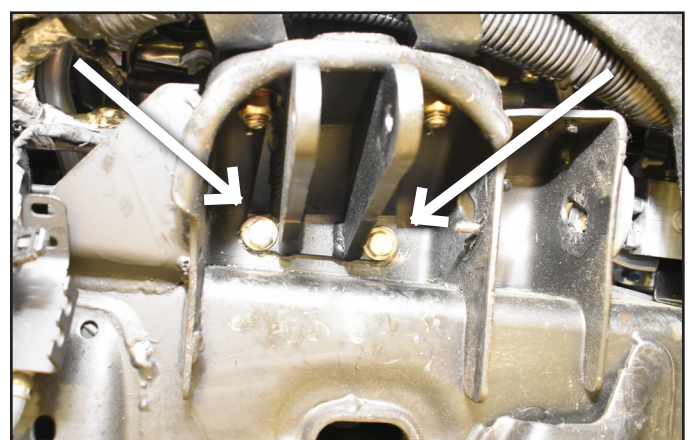


FIGURE 23B



30. Install the upper coilover bracket with 1/2" x 1-1/2" hardware through the original upper mount, attach the reservoir bracket to the top side, as shown in Figure 32A. Leave hardware loose. Attach the two lower holes with 7/16" x 1-1/4" hardware from bolt pack 891. Tighten the 7/16" hardware first to 59 ft-lbs followed by the 1/2" hardware to 90 ft-lbs.

TIE ROD INSTALLATION

31. Unthread the inner tie rod from the center steering link.
32. Measure the length of the OE tie rod assembly from the mount face on the inner tie rod to the center of the outer tie rod. Unthread the new HD tie rod assembly to be as close as possible to the OE tie rod assembly length plus one inch. (Fig. 24) Leave jam nut loose.

FIGURE 24



33. Apply thread locker to the new HD inner tie rod end. (Fig. 25)

FIGURE 25



34. Thread on the new HD inner tie rod end to the center steering link. Tighten to 118 ft-lbs. using provided crow foot. (Fig. 26)

FIGURE 26



35. Apply a small amount of grease to the lip of the rubber boot seal on the outer tie rod to prevent twisting or deforming of the boot.
36. Install the outer tie rod into the steering knuckle using the provided nut. Tighten to 26ft-lbs with the first pass and a final pass of 85-100 degrees. (Fig. 27)

FIGURE 27



37. Tighten the jam nut against the outer tie rod. (Fig. 28)

FIGURE 28



38. Install the BDS upper control arms at this time. Use the factory cam bolts, washers, and nuts. Do not torque to specification at this time. Center the cams and snug hardware. (Fig. 29A, 29B)

FIGURE 29A



FIGURE 29B



39. The bump stop mount will need to be clearanced for the coilover. This may require a clearance check after the coilover has been installed. Do not weld this clearance plate in until clearance to the coilover has been checked. (Fig 30A & B)

Note: The coilover will have very tight clearance to this area of the frame. In most cases at full droop the coil spring may touch the frame. This is caused by the coil spring bowing in one direction. The coil spring may need to be rotated to avoid the spring contacting the frame.

FIGURE 30A (BEFORE)

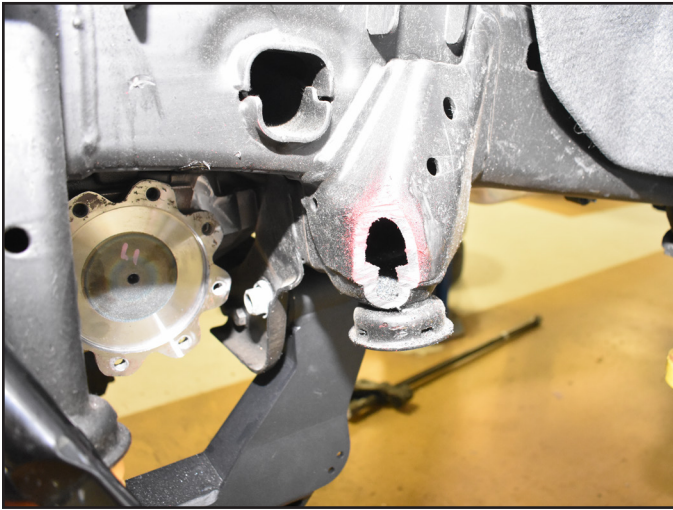
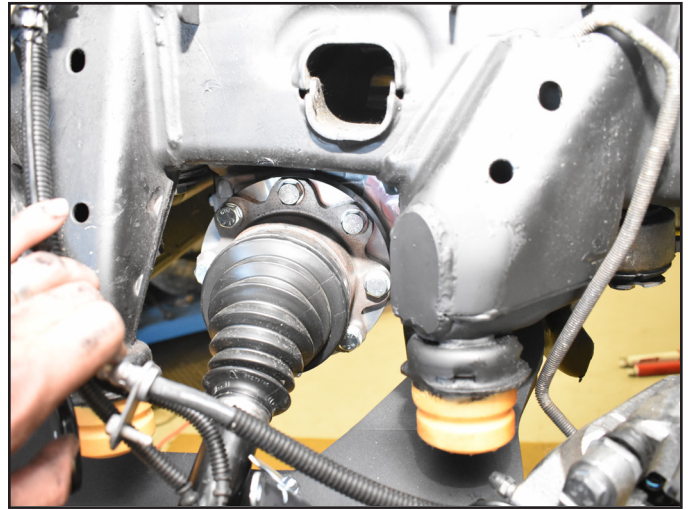


FIGURE 30B (AFTER)

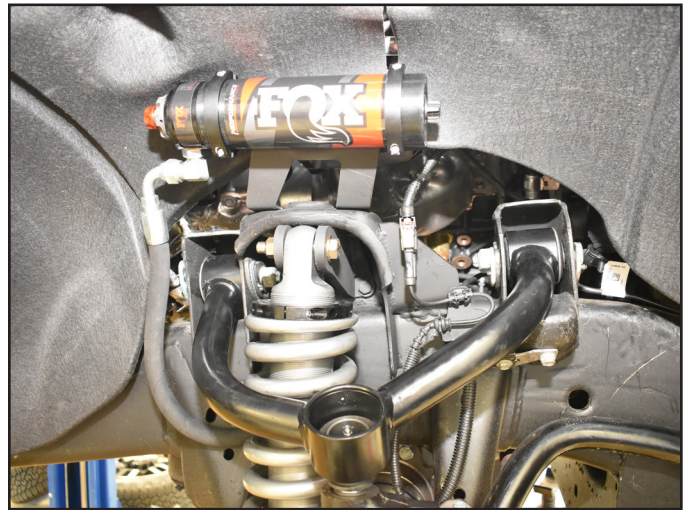


40. Install the coilover at this time with the hose pointed inwards towards the center of the vehicle. The reservoir hose will run out the back towards the rear of the vehicle as shown in (Fig. 31A, 31B). Attach to the upper bracket with 1/2" x 3-1/4" bolt and 1/2" hardware from bolt pack 891.

FIGURE 31A



FIGURE 31B



41. Torque the upper and lower coilover mounting hardware to 90 ft-lbs.
42. Attach the large tube clamp in bolt pack 891 to the reservoir hose so that it sits on the rear OE bump stop bracket. Drill a 17/64" hole where the hole is in the large tube clamp through the OE bump stop bracket. Attach to the frame using the provided 5/16"-18 self threading bolt. Add image of hole with, clamp added - 066, 064

FIGURE 22A

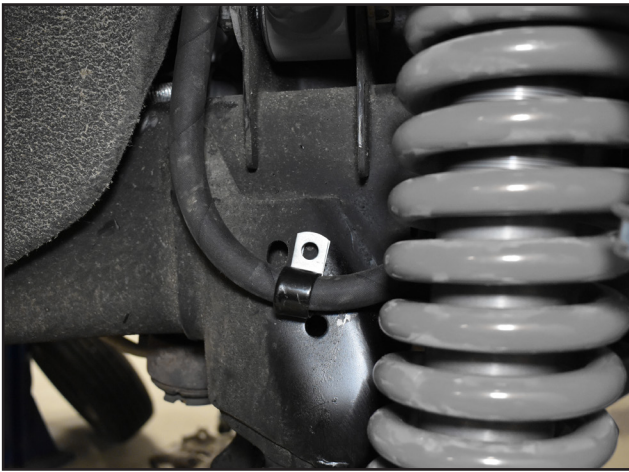
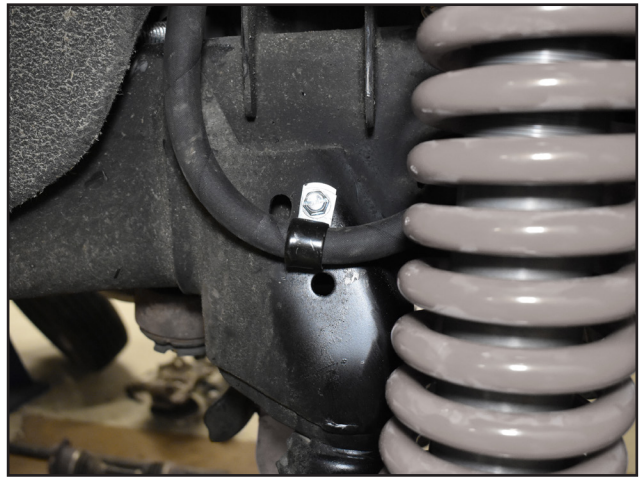


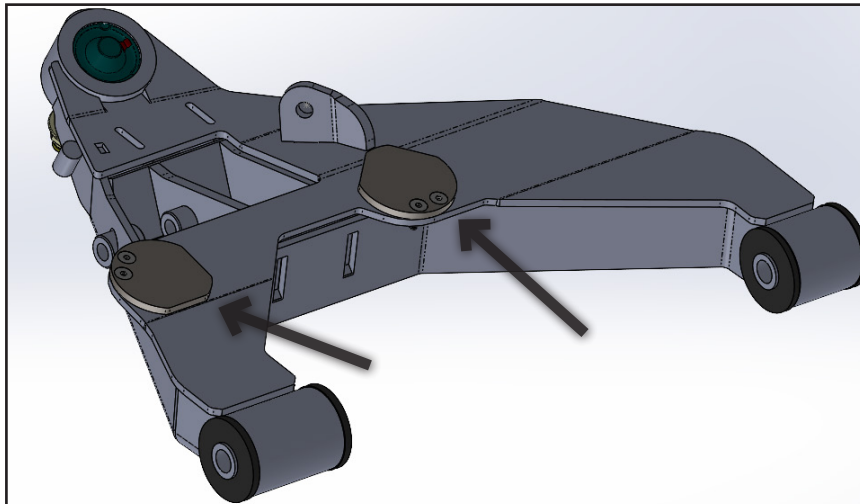
FIGURE 22B



43. If the desired lift height is 3" of lift as intended out of the box, the 1/4" bump stop spacers will need to be installed onto the lower control arm using the flat head screws and hardware from bolt pack BP1041. See Figure 23 for bump stop spacer installation. Torque the flat head screw hardware to 86 in-lbs.

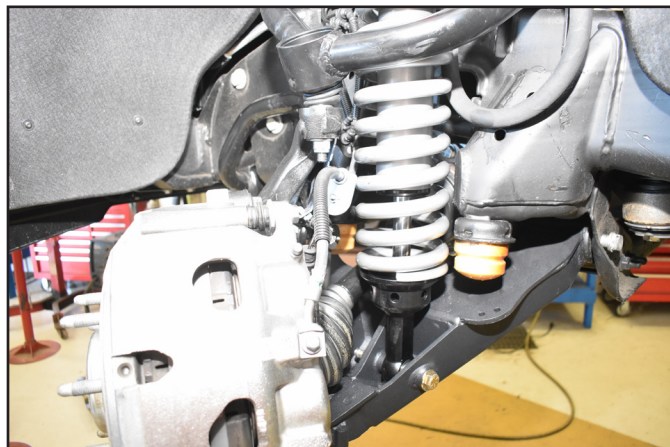
Note: Do NOT increase preload over 3" of lift as supplied.

FIGURE 23



44. Install new lower control arms with 18mm OE hardware to the frame. Do not tighten the hardware at this time.
45. Attach the lower control arm to the lower coilover mount with 1/2" x 5" bolt and 1/2" hardware from bolt pack 891. (Fig 24)
46. Torque the 1/2" hardware for the upper and lower coilover mounts to 90 ft-lbs.

FIGURE 24



47. Reinstall the factory steering knuckle to the new lower control arm with the included nut.
48. Install the CV shaft into the hub assembly, do not attach to the differential at this time.
49. Raise and support the lower control arm.
50. Swing the knuckle and CV assembly up and attach the upper ball joint and insert CV shaft into the differential assembly. (Fig. 25A)
51. Tighten the CV nut with 34mm socket to 244 ft-lbs, then loosen 45 degrees. The final pass the CV nut should be torqued to 199 ft-lbs.
52. Reinstall the CV dust cap.
53. Install the CV axle onto the differential output flange with the provided aluminum CV spacer (Fig. 25B). Align the differential flange holes and fasten with the provided 12mm hardware in bolt pack 890. Apply thread locker to the threads and torque to 74 ft-lbs.

FIGURE 25A

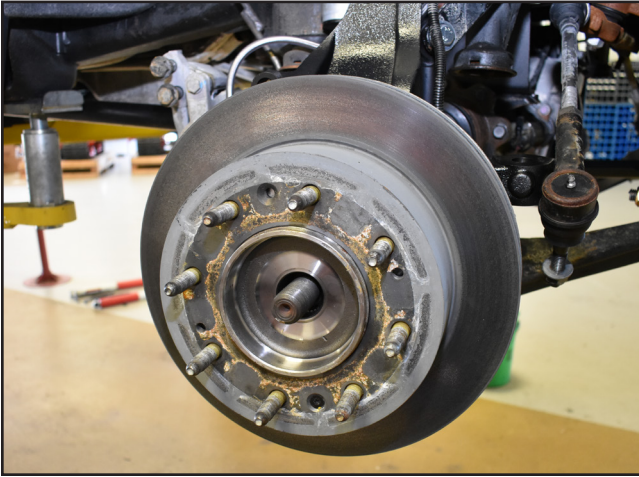
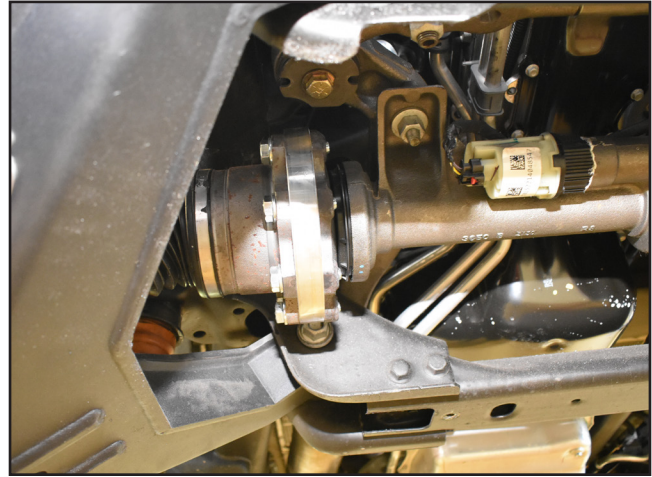


FIGURE 25B

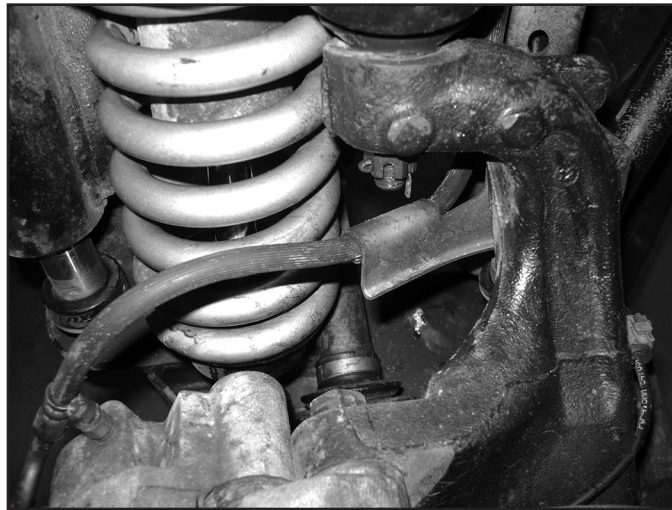


54. Reinstall the brake rotors with flat head torx bolt.
55. Reinstall the brake calipers with thread locker on factory hardware. Tighten to 125 ft-lbs.
56. Reattach the brake line bracket to the steering knuckle with factory hardware and use provided wire clamp (Bag Kit B1158) to attach ABS wire (Fig 26A). Bend the stock brakeline bracket to get the bracket to clear the coilover. (Fig 26B)

FIGURE 26A

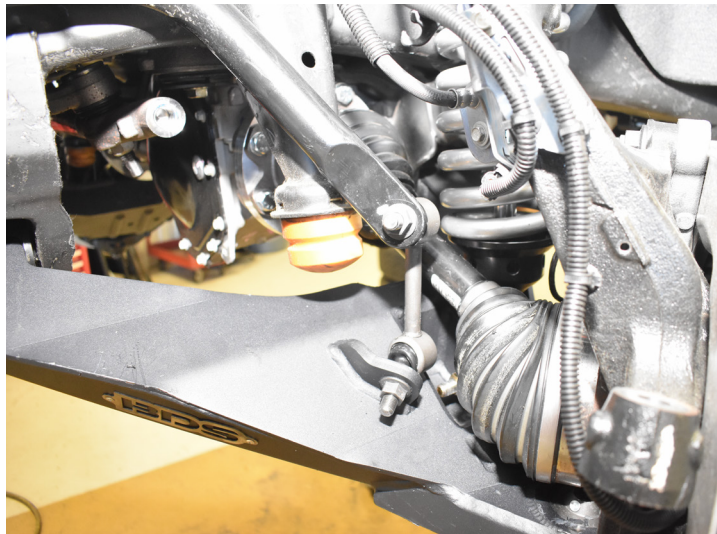


FIGURE 26B



57. If the torsion bar cross-member was removed, re-install with factory hardware. Reconnect the exhaust sensor plug. Attach the clip to the cross-member.
58. Locate the new front sway bar links. Install the sway bar links on the back side of the sway bar towards the CV shaft. This will make sure the joint angles are not overextended. Torque the sway bar link hardware to 55 ft-lbs. (Fig. 27)

FIGURE 27



59. Reattach the ABS sensor plugs next to the upper coilover mount. Use zip tie to retain wire from flopping around.

FINAL FRONT INSTALLATION

60. Reinstall skid plate and splash shield with factory hardware.
61. Grease upper and lower ball joint(s) at this time.
62. Install O-ring onto the upper ball joint cap. Use the included grease packet to lightly grease the o-ring and insert into the upper control arm. Press and twist the cap to get it to pop into the upper control arm. (Fig 28)

FIGURE 28



Note: Use a large flat blade screw driver to remove the upper ball joint cap to access the grease fitting during service intervals.

63. Cycle steering to ensure that all parts have enough clearance / slack and there is no interference.
64. Install the front wheels. Torque the lug nuts to 140 ft-lbs. Lower the vehicle to the ground.
65. Repeat steering sweep to ensure that all parts have enough clearance / slack and there is no interference.
66. Bounce the front end to settle the suspension.
67. Torque the lower control arm bolts (4) to 133 ft-lbs and then a final pass of 45-75 degrees.
68. Center the upper control arm cams. Tighten the cam bolts to 192 ft-lbs.
69. Check all front hardware for proper torque.

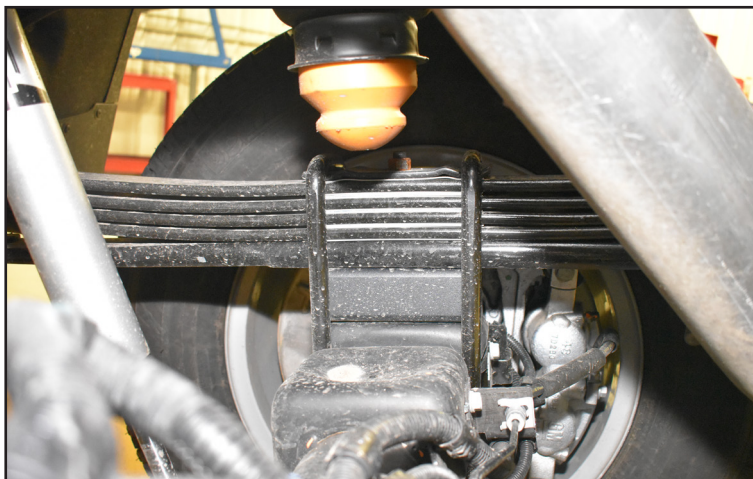
REAR INSTALLATION

1. Block the front wheels for safety. Raise the rear of the vehicle and support with jack stands under the frame rails, just ahead of the front leaf spring hangers.
2. Remove the wheels.
3. Raise rear of vehicle and support frame with jackstands.
4. Support the rear axle with a hydraulic jack.
5. Disconnect the rear shocks from the axle and frame end. Discard the rear shocks. Save hardware.
6. With the axle well supported, remove the passenger's side u-bolts and lower u-bolt plate. Loosen, but do not remove the u-bolt hardware on the driver's side. This will allow the axle to move more easily and aid in installation. Check slack on any brake lines or ABS lines.

2" LIFT BLOCK INSTALLATION

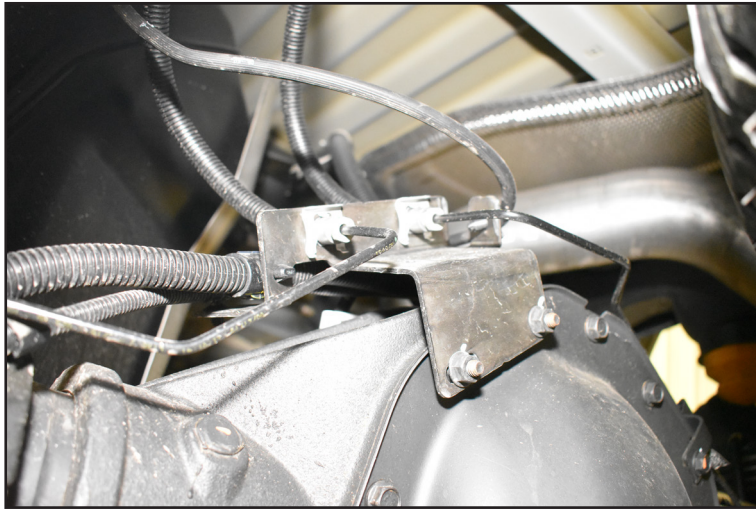
7. Install the new blocks between the axle and the leaf spring. Align the pins/holes and raise the axle to seat the assembly. Install the new provided u-bolts with the factory u-bolt plate. (**Fig. 34**) Fasten with the provided locking flange nuts. Snug hardware. Final torque will be down with the vehicle on the ground.

FIGURE 34



8. Repeat block installation of the driver's side.
9. Check all cables for adequate slack at full droop, make adjustments if necessary. (fig. 35)

FIGURE 35



10. Attach the new shocks to the axle and frame with factory hardware. Torque hardware to 85 ft-lbs. (Fig. 36)

FIGURE 36



11. If installed remove clips on wheels (Fig. 37). Reinstall wheels and lower vehicle to the ground.

FIGURE 37



12. Reinstall the wheels and lower the vehicle to the ground. Torque lug nuts to 140 ft-lbs in a crossing pattern
13. Roll the vehicle forward and back to settle the suspension.
14. Torque u-bolts to 150 ft-lbs.

POST-INSTALLATION

15. Check all hardware for proper torque.
16. Reconnect the positive and negative battery cables.

17. The vehicle will need a complete front end alignment.
18. Check all hardware after 500 miles.
19. Adjust headlights.



WE WANT TO SEE YOUR RIDE!

Grab photos of your BDS-equipped truck in action and send them in for a chance to be featured. Send it in to our Bad Ass Rides customer gallery at bds-suspension.com/bar and post them on the BDS Fan Page on Facebook at facebook.com/BDSSuspensions. Don't forget about your BDS swag! BDS offers t-shirts, hoodies, decals and more available on the BDS website or through your local BDS distributor.

TIME TO HAVE SOME FUN

Thank you for choosing BDS Suspension.

For questions, technical support and warranty issues relating to this BDS Suspension product, please contact your distributor/installer before contacting BDS Suspension directly.